

# FMC2000

## User's Guide



## FCC Information

The enclosed device complies with part 15 of the FCC rules. Operation is subject to the following conditions: (1) This device may not cause harmful interference, and (2) This device must accept any interference received, including interference that may cause undesired operation.

## Proper Product Disposal At End Of Life



This symbol (crossed-out wheeled bin) indicates separate collection of waste electrical and electronic equipment in the EU countries.

This product may contain one or more lead-acid, Nickel-metal hydride (NiMH), Lithium-ion, or Alkaline batteries. Specific battery information is given in this user guide.

Batteries must be recycled or disposed of properly.

At the end of its life, this product must undergo separate collection and recycling from general or household waste. Please use the return and collection system available in your country for the disposal of this product.

# FMC2000 User's Guide

## Contents

1	Special Notes .....	6
	Warnings.....	7
2	Standard Contents.....	8
3	General Information .....	8
3.1	Key Features.....	8
4	Physical Description.....	9
4.1	Rear View and Side View Of Enclosure .....	10
4.2	Mounting the FMC2000.....	10
4.3	Drilling Chart.....	12
5	Specifications .....	13
6	Charging The Internal Backup Battery.....	14
6.1	Clock Battery.....	14
6.2	Data Protection While Power Is Off.....	14
6.3	SD Card .....	14
7	User Interface .....	16
7.1	Status LEDs .....	17
7.2	Display.....	17
7.3	Keypad.....	18
7.4	Alarms .....	18
7.5	Preparing The FMC2000 For Data Storage .....	19
8	Operating The FMC2000 .....	22
8.1	Turning The FMC2000 On.....	22
8.2	Turning The FMC2000 Off .....	24
9	Display Information.....	25
9.1	Display Icons .....	26
10	Navigation .....	28
11	Normal Operation Mode Controls.....	29
11.1	Radio Silent (Enable/Disable) .....	29
11.2	Reset .....	29
11.3	Silence Alarm .....	30
11.4	Check (Alarm Details).....	31
11.5	Monitoring.....	33
11.5.1	Detail Info.....	33
11.5.2	MeshGuard EC Or LEL.....	34

# FMC2000 User's Guide

11.5.3	MeshGuard Router .....	36
12	Configuration.....	37
13	General Settings Menu .....	38
13.1	Basic Settings .....	39
13.2	Date Format .....	40
13.3	Date.....	40
13.4	Time Format .....	41
13.5	Time.....	41
13.6	Language .....	43
13.7	Backlight.....	43
13.8	Instrument Location.....	44
13.9	Serial Number.....	44
13.10	Firmware Version.....	44
13.11	Build Date.....	44
13.12	Build Time.....	44
14	Advanced Settings .....	45
14.1	Basic Password.....	45
14.2	Advanced Password.....	46
14.3	Online Monitors.....	46
14.4	Delete Monitors Configuration.....	47
14.5	Delete Relay Configuration .....	47
14.6	EchoView .....	47
14.7	Alarm Buzzer.....	47
14.8	Alarm Light .....	48
14.9	Backup Configuration .....	48
14.10	Restore Configuration .....	48
14.11	Factory Reset .....	49
15	Wireless Detector Settings .....	49
15.1	Modem ID .....	50
15.2	Location .....	50
15.3	Data Interval .....	50
15.4	Sensor Type .....	51
15.5	Unit .....	51
15.6	Low .....	51
15.7	High .....	51
15.8	STEL.....	51

# FMC2000 User's Guide

15.9	TWA .....	52
15.10	Full Scale .....	52
15.11	Drift .....	52
15.12	Reset LEL .....	52
16	Relay Settings .....	53
16.1	Relay Ratings (Resistive) .....	53
16.2	Type .....	54
16.3	DON .....	54
16.4	DOF .....	55
16.5	Lock .....	55
16.6	Vote .....	56
16.7	Num .....	57
16.8	Slave ID .....	57
17	Datalog Settings Menu .....	58
17.1	Datalog .....	58
17.2	Log Interval .....	59
17.3	Log Method .....	59
17.4	SD Card Info .....	60
18	Communications Menu .....	61
18.1	Wireless Modem .....	62
18.1.1	Form a Network .....	62
18.1.2	Radio Synch .....	62
18.1.3	Radio PanID .....	63
18.1.4	Del Binding .....	64
18.1.5	Channel .....	64
18.1.6	Ping Network .....	64
18.2	Ethernet Network .....	65
18.2.1	TCPIP Enable .....	65
18.2.2	Protocol Select .....	66
18.2.3	Server IP .....	67
18.2.4	Server Port .....	67
18.2.5	Client IP .....	67
18.2.6	Subnet Mask .....	68
18.2.7	Dflt Gateway .....	68
18.2.8	Re-Obtain IP .....	69
18.2.9	Client MAC .....	69

# FMC2000 User's Guide

18.3	RS485 .....	70
18.3.1	Baud Rate .....	70
18.3.2	Client ID .....	71
18.3.3	MB Type.....	71
18.3.4	Protocol.....	72
18.3.5	Monitor Address .....	72
19	Diagnostic Menu .....	73
19.1	Relay Output Diagnostic .....	73
20	Transferring Data From The SD Card.....	75
21	After Transferring Data From The SD Card .....	77
22	Maintenance .....	79
22.1	Battery Charging & Replacement .....	79
22.2	SD Card Replacement .....	79
22.3	Special Servicing Note .....	80
23	Troubleshooting.....	81
24	Technical Support.....	83
25	RAE Systems Contacts.....	84
26	Appendix A: Wiring The FMC2000 .....	87
26.1	DC Wiring .....	87
26.2	AC wiring .....	87
27	Appendix B: Wiring To External Alarms .....	91
27.1	Wiring Blocks In The FMC2000 .....	89
27.2	Relay Electrical Drawing .....	90
27.3	Checking Relay Continuity .....	91
27.3.1	Power Supply Connections.....	92
27.3.2	Dry Contact Operation .....	93
28	Appendix C: Connecting RS485 (Modbus) .....	93
29	Appendix D: Connecting Ethernet .....	94
30	Appendix E: Connecting to a Light/Alarm Bar.....	95
31	Appendix F: Formatting An SD Card For FAT32 .....	96
31.1	Formatting An SD card .....	96
32	Appendix G: ModBus Protocol For The FMC2000... 102	
32.1	Overview .....	102
32.2	Communications Settings.....	102
32.3	Message Frame/Communication Procedure.....	103
32.4	Registers Table .....	104

## **FMC2000 User's Guide**



### **Read Before Operating**

This manual must be carefully read by all individuals who have or will have the responsibility of using, maintaining, or servicing this product. The product will perform as designed only if it is used, maintained, and serviced in accordance with the manufacturer's instructions. The user should understand how to set the correct parameters and interpret the obtained results.

#### **CAUTION!**

To reduce the risk of electric shock, turn the power off before opening this instrument or performing service. Never operate the instrument when the instrument is open. Use and service this product only in an area known to be non-hazardous.

## 1 Special Notes

-  If the battery backup is completely discharged, the power switch must be turned off and on when the main power is restored.
  
-  An SD card is required for storing datalog information. If the card is not factory formatted for FAT32, it must be formatted before use. See Appendix C.
  
-  The FMC2000 must be properly grounded. Follow local electrical codes when installing and using. Connect a ground wire to the bolt inside the front panel to ground the chassis:

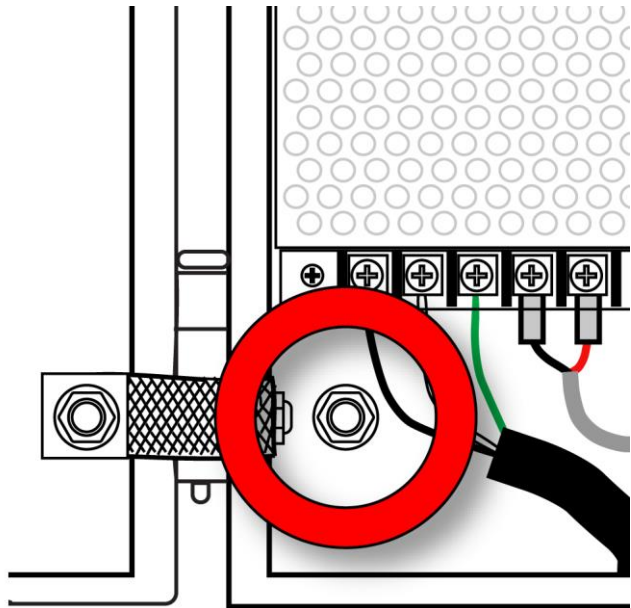



## FMC2000 User's Guide

### **WARNINGS**

Use only in non-hazardous locations.

For safety reasons, this equipment must be operated and serviced by qualified personnel only. Read and understand instruction manual completely before operating or servicing.

### **AVERTISSEMENT**

Utiliser uniquement en zone non-dangereuse.

Pour des raisons de sécurité, cet équipement doit être utilisé, entretenu et réparé uniquement par un personnel qualifié. Étudier le manuel d'instructions en entier avant d'utiliser, d'entretenir ou de réparer l'équipement.

## 2 Standard Contents

- Controller mounting plate (as specified)
- Key for cabinet lock
- SD memory card, P/N 550-0300-000
- Installation guide/quick-start guide
- CD-ROM with User's Guide, Quick-Start Guide, and related materials

## 3 General Information

The FMC2000 Multi Controller works with RAE Mesh wireless detectors, such as MeshGuard, RAETag, RAEWATCH, for various safety applications.

### 3.1 Key Features

- Rapid deployment.
- Wireless mesh network communication.
- 5.7" high-contrast graphic LCD display. Good for outdoor applications.
- Integrated visual indicator and audio alarm.
- 5 SPDT relays for alarms and fault.
- Datalogging storage on SD card.
- Configuration storage/retrieval on SD card.
- Can manage up to 24 wireless monitors.
- User programmable.
- Wide power input range: 100V to 240VAC

## 4 Physical Description

The main components of the FMC2000 include:

- 16 keys for programming and reviewing settings
- LCD display with back light for direct readout and readout from MeshGuard monitors
- Buzzer and red light for alarm signaling whenever exposures exceed preset limits
- Key-lockable panel
- Stainless-steel housing

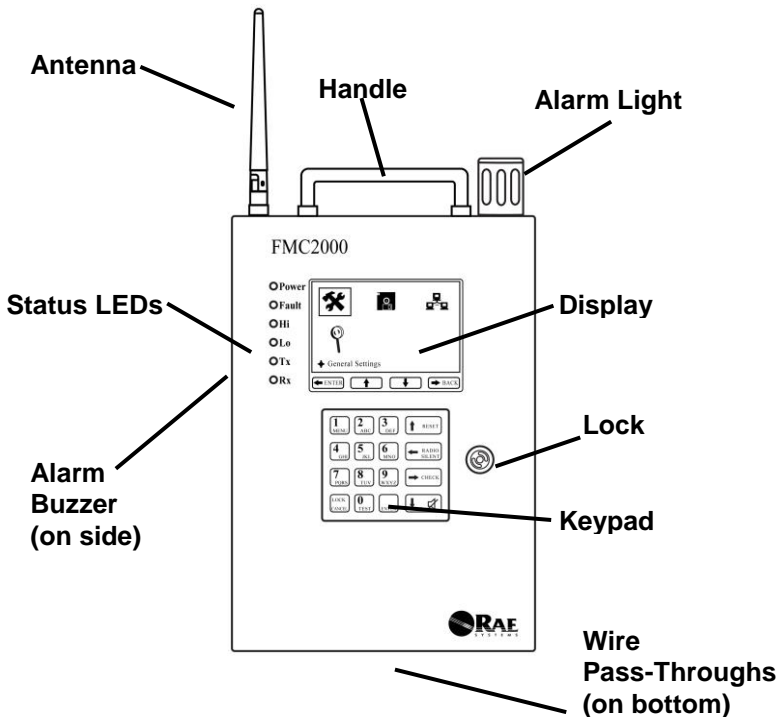

# FMC2000 User's Guide

## 4.1 Rear View and Side View Of Enclosure

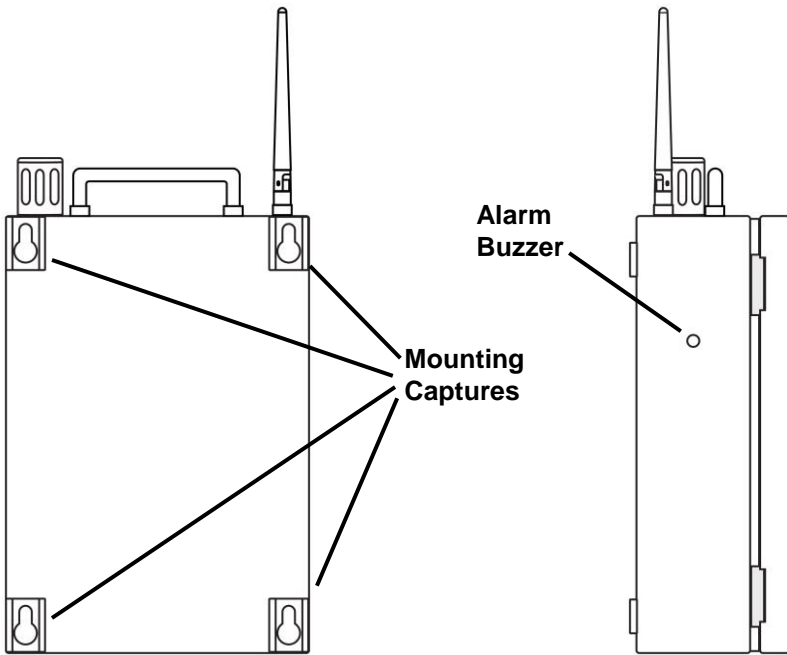

## 4.2 Mounting the FMC2000

The FMC2000 is designed to be wall-mounted and has four keyhole-type captures on its back, allowing for attachment to four mating studs extending from a bracket that is designed to be pre-installed on a wall.

Follow these steps:

1. Install the mounting plate first. Mark the locations for the six screws.

## FMC2000 User's Guide

2. Drill the holes and screw the bracket to the wall.

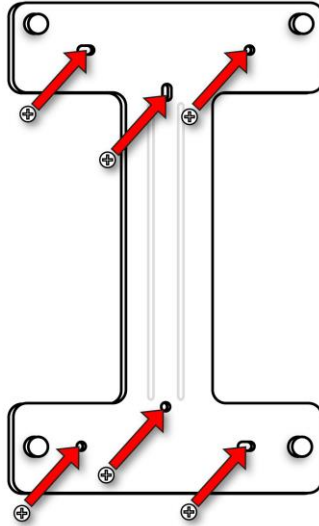

3. Support the weight of the FMC2000 and align the large ends of the keyhole-shaped mounting captures on the rear of the enclosure with the four studs protruding from the bracket.

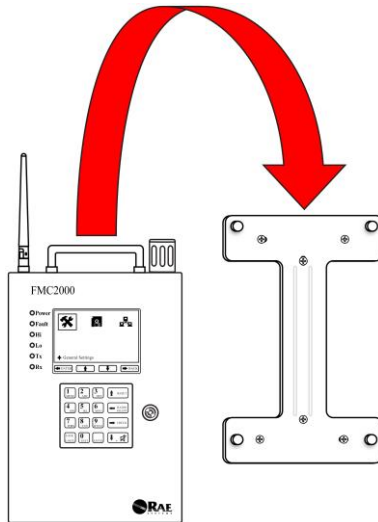

# FMC2000 User's Guide

4. Ensure the shafts of the mounting plate's studs rest firmly in the narrow end of the keyhole-shaped captures, and then let the bracket fully bear the weight of the FMC2000.

## 4.3 Drilling Chart

When mounting the FMC2000 on a wall, make sure to use heavy-duty steel screws spaced as indicated below.

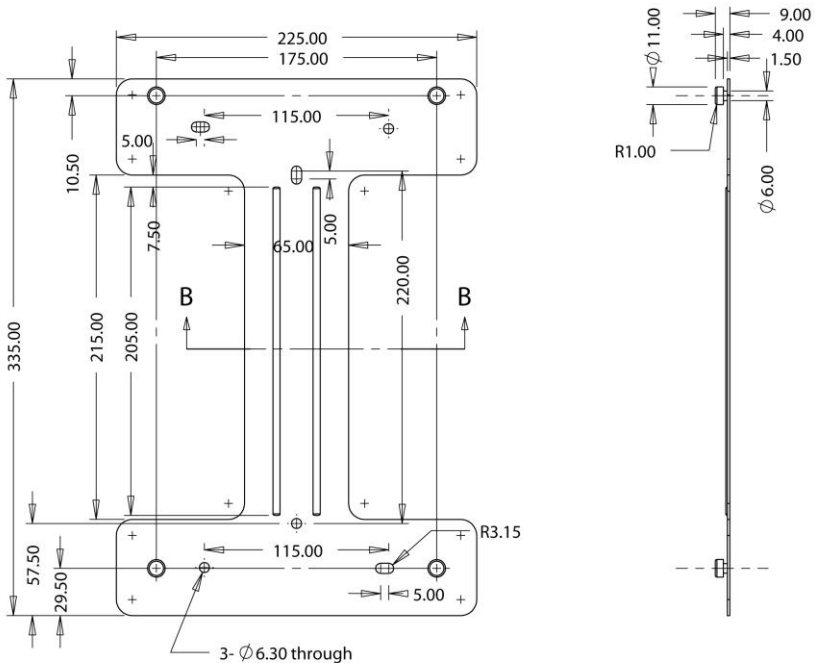

**Note: All dimensions are in millimeters.**

## FMC2000 User's Guide

### 5 Specifications

<b>Size</b>	9.5" W x 15.7" H x 3.7" D (24cm x 40cm x 9.3cm)
<b>Weight</b>	14.3 lbs (6.5 kg), excluding mounting plate
<b>LCD Display</b>	5.7" (15cm) 320x240 Black/White graphic LCD with backlight
<b>Audible alarm</b>	95dB @ 30cm (12")
<b>Visual alarm</b>	Super-bright red LED with enclosed cover
<b>Keypad</b>	16 metal keys
<b>Real-Time Clock</b>	YY/MM/DD,HH:MM:SS
<b>Datalogging</b>	SD card
<b>Wireless</b>	2.4GHz IEEE 802.15.4/ mesh radio
<b>Wireless Detectors</b>	24 channels
<b>Relays</b>	Resistive Load Max: 6A@24VDC or 6A@250VAC Limiting making current Max: 10A Breaking switching power capacity Max: 1200VA
<b>Housing</b>	Stainless steel
<b>Power Supply*</b>	100V to 240V AC
<b>Backup Battery</b>	Rechargeable lead-acid battery 12V 2.8AH, 15 hours of operation
<b>Operating Temperature</b>	-20° C to +55° C
<b>Approvals</b>	FCC: SU3RM2400A
<b>EC Compliance (European Conformity)</b>	EMC Directive : 2004/108/EC
	R&TTE Directive : 1999/5/EC
	LVD Directive : 2006/95/EC
<b>Humidity</b>	0% to 95% RH, non-condensing

\*Power source must be protected by a circuit breaker or fuse rated at 15A or less.

### Brazil Radio Specifications

**Radio model:** RM2400A

**Frequency range:** 2.400-2.4835GHz

**Modulation:** 802.15.4 DSSS BPSK

**RF power(Tx):** 20dBm

**Data rate:** 250kbps

## 6 Charging The Internal Backup Battery

Whenever AC power is supplied to the FMC2000, the internal backup battery is always being charged. The backup battery ensures continuous operation if the AC power source is interrupted. It is fully charged after 6 to 8 hours of operation. The FMC2000 can run for up to 15 hours on the backup battery.

### 6.1 Clock Battery

An internal clock battery is mounted on the top printed circuit board. This long-life battery keeps settings in memory from being lost whenever the power is turned off or disconnected. This clock battery should last approximately five years, and must be replaced by an authorized RAE Systems service technician. It is not user-replaceable.

### 6.2 Data Protection While Power Is Off

When the FMC2000 is turned off, all the current real-time data including last measured values are erased. However, the datalog data is preserved on an SD card if it is installed. Even if the battery is disconnected, the datalog data will not be lost.

### 6.3 SD Card

The FMC2000 uses an SD (Secure Digital) card for datalog storage. (The part number from RAE systems is 550-0300-000.)



## FMC2000 User's Guide

### **WARNING!**

Whenever you replace the SD card, the FMC2000 must be either turned off or in standby mode (see page 19). Otherwise, data may be lost or the SD card may be corrupted. See “Preparing The FMC2000 For Data Storage” on page 19 for details on safely inserting and removing an SD card.

### **IMPORTANT!**

The SD card that comes with the FMC2000 is pre-formatted and ready for use. If you purchase an SD card from another vendor, its capacity must be 2GB or less. In addition, it may need to be formatted before it can be used in the FMC2000. RAE Systems cannot guarantee SD cards from other sources will work with the FMC2000. Refer to Formatting An SD Card on page 95 for details.

**Note:** The SD card inside the FMC2000 should only be used for FMC2000 data recording. Do not save other files to the SD card. In addition, do not use one SD card for more than one FMC2000 or exchange it from one FMC2000 to another.

Transferring records from the SD card to a PC every 6 month is recommended. This enhances data security and speeds the data-transfer process.

## 7 User Interface

The instrument's user interface consists of the display, status LEDs, an alarm buzzer, an alarm light, and 16 keys.

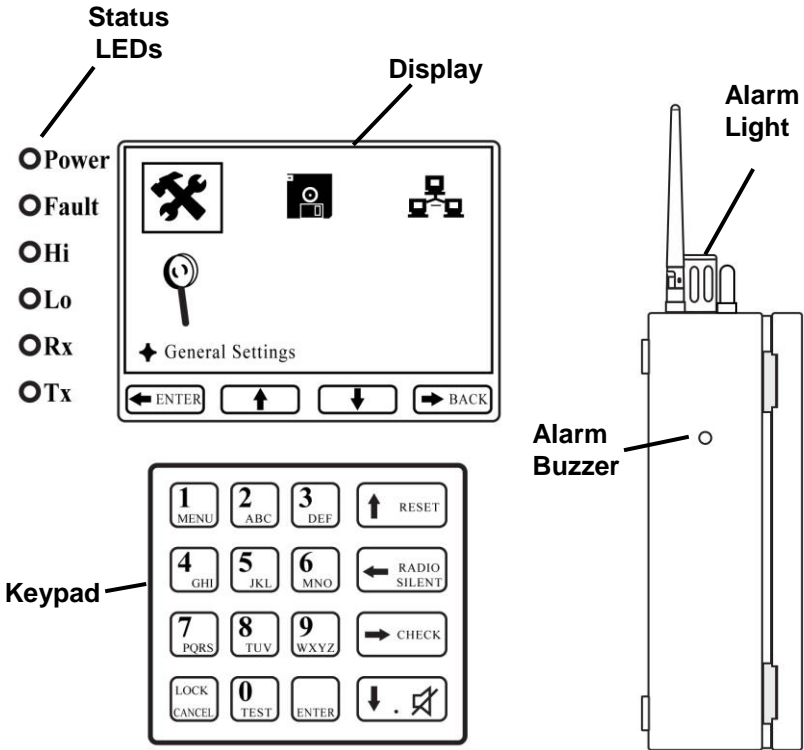

# FMC2000 User's Guide

## 7.1 Status LEDs

The status LEDs provide the following basic visual information:

LED	Information
Power	Glows green when the FMC2000 is on
Fault	Glows orange when problem is encountered
Hi	Glows red during High Alarm
Lo	Glows red during Low Alarm
Rx	Glows green when receiving data from a remote device
Tx	Glows green when transmitting data to a remote device

## 7.2 Display

The LCD display provides visual feedback that includes the reading, time, battery condition, and other functions. It also includes “soft key” indicators along the bottom that show the relationship of functions with the large buttons arranged vertically along the keypad’s right side.

The screenshot shows the LCD display with the following elements:

- Top status bar: Signal strength, battery level, and time **10/30 10:30AM**.
- Main data table:

NO	ID	LOCATION	READING	SENSOR	OK
1	330E	#####	1	CO	<input checked="" type="checkbox"/>
2	330B	#####	0	CO	<input checked="" type="checkbox"/>
3	330F	#####	0	H <sub>2</sub> S	<input checked="" type="checkbox"/>

Below the table are three status indicators:

- 1st ALM:** (empty)
- FAULTS: 0**
- ALARMS: 0**

At the bottom are five control buttons:

- ← RADIO SILENT**
- ↑ RESET**
- ↓** (down arrow)
- ⊗** (mute icon)
- CHECK**

## FMC2000 User's Guide

### 7.3 Keypad

The keypad is used to navigate the menus and parameters in the FMC2000. Many of the keys perform dual functions, and the four large keys arranged vertically along the right side correspond to the “soft key” icons arranged along the bottom of the display.

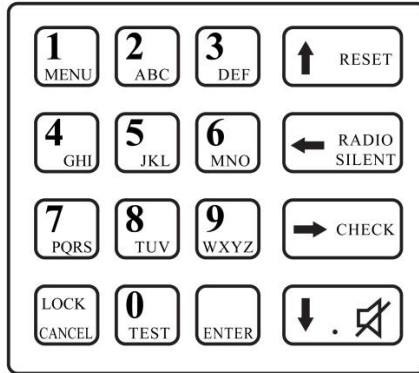

### 7.4 Alarms

Three types of alarms can occur:

- Fault
- Low alarm
- High alarm

A fault alarm occurs when there is a low battery in a monitor transmitting to the FMC2000, when a monitor goes “offline” or out of range (and its signal is no longer received), or when there is an internal problem with the FMC2000. Low and high alarms occur when any of the network’s monitors’ thresholds are exceeded.

**Note:** If a low alarm is triggered and then a high alarm, the low alarm continues to occur until all alarms are cleared.

## FMC2000 User's Guide

### 7.5 Preparing The FMC2000 For Data Storage

Before operating the FMC2000, make sure it has an SD card in the memory slot. This is necessary for storing datalog information.

1. Unlock the FMC2000.
2. Open the door.

The SD card slot is on the main PC board as shown:

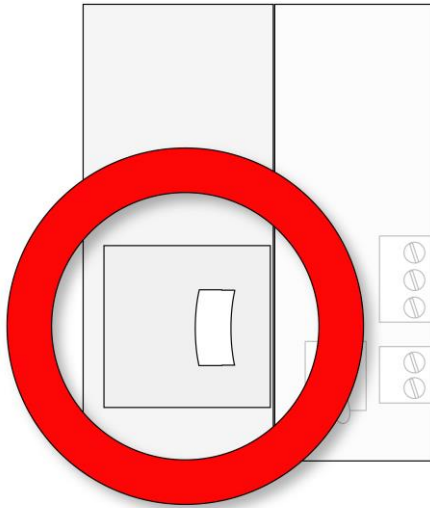

#### **IMPORTANT!**

Before inserting or removing an SD card, the FMC2000 must be turned off, datalogging turned off, or the FMC2000 placed in Standby Mode. For details on turning datalogging off, see page 58. For details on turning the FMC2000 off or on, see page 22.

## FMC2000 User's Guide

### To place the FMC2000 in Standby Mode and replace the SD card:

1. Hold down the “2” key until you see the display message “Standby...” The screen goes blank.
2. Release the “2” key.
3. Unlock and open the front panel.
4. Check that LED next to the SD card is not blinking.
5. Remove SD Card by pressing in (lightly), and allowing it to release.
6. Replace the SD card.

### To exit Standby Mode and restart datalogging:

1. Hold down the “2” key. The screen illuminates and gives the message “Working...”
2. Release the “2” key.

When the reading display is shown, datalogging is on again, and the FMC2000 is fully operational.

**Inserting an SD card.** Press the SD card into the slot with the angled notch on the right. Press until it locks into place, making a “click” sound.

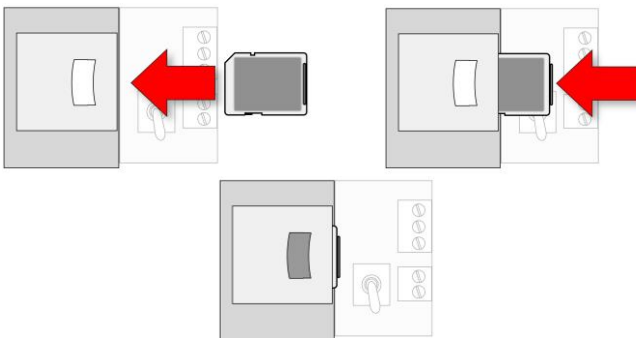

## FMC2000 User's Guide

**Removing an SD card.** Press the SD card and release it. It will make a click and push part of the way out of the slot.

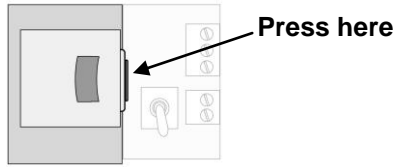

The FMC2000 cannot write data to a locked SD card. If the SD card is locked, remove it and unlock it by moving the lock tab; then reinsert the SD card.

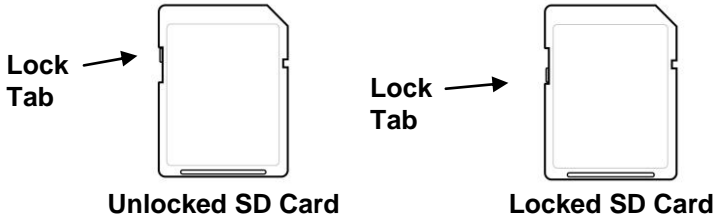

If remaining space for data on the SD card is very low, the FMC2000 alerts you with a message on the screen. Replace the SD card with another with more space on it, or offload the data to a computer. Then erase the data from the card, using your computer, and reinsert the SD card back into the FMC2000.

### **IMPORTANT!**

Keep enclosure closed whenever an SD card is not being inserted or removed. This helps to keep the reading mechanism and the SD card clean, especially in dusty environments.

## 8 Operating The FMC2000

The FMC2000 starts up quickly and requires no intervention on the part of the user, other than turning on the power switch. Once it is powered up, the FMC2000 performs self-tests and automatically initiates communications.

### 8.1 Turning The FMC2000 On

1. Connect the FMC2000 to a source of AC power.
2. With the FMC2000 turned off, unlock the front panel with the key, and flip the small toggle switch located next to the SD card.

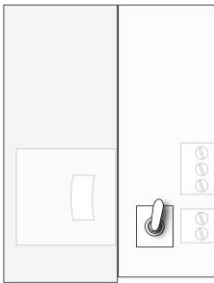

**Switch in "on" position**

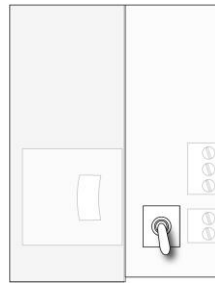

**Switch in "off" position**

LEDs inside the FMC2000 indicate proper operation:

- If the radio transmitter is on, the LED next to it should blink.
  - If datalogging is turned on, the LED next to the SD card should blink.
3. Close and lock the front panel.



# FMC2000 User's Guide

A screen with the RAE Systems logo appears first. (If the logo does not appear, there is likely a problem and you should contact your distributor or RAE Systems Technical Support.)



**MULTI CONTROLLER**

FMC2000P V2.00



[www.raesystems.com](http://www.raesystems.com)

The FMC2000 performs self-tests on its LCD, LEDs, and buzzer. It also initializes connection with a wireless network or Ethernet interconnection (if it is configured for Ethernet networking). After 30 seconds, the display shows the monitoring screen, indicating that it is monitoring the system. It is now fully operational. If any tests fail, refer to the Troubleshooting section of this guide.

Once the startup procedure is complete, the instrument shows readings from any MeshGuard sensors on the network:

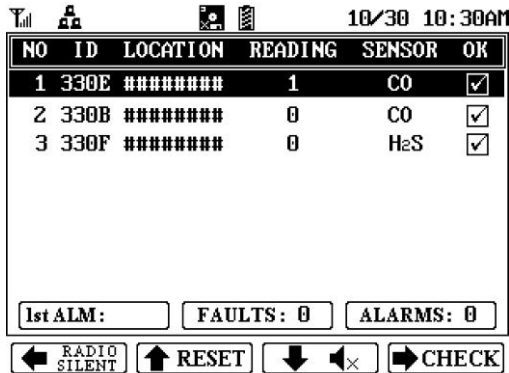

The screenshot shows the FMC2000 monitoring screen. At the top, there are status icons for signal strength, battery, and a gear icon, followed by the date and time: 10/30 10:30AM. Below this is a table with columns: NO, ID, LOCATION, READING, SENSOR, and OK. The table contains three rows of data. Below the table are three buttons: 1st ALM:, FAULTS: 0, and ALARMS: 0. At the bottom are five navigation buttons: RADIO SILENT (with a left arrow), RESET (with an up arrow), a down arrow with a speaker icon and an 'x', and CHECK (with a right arrow).

NO	ID	LOCATION	READING	SENSOR	OK
1	330E	#####	1	CO	<input checked="" type="checkbox"/>
2	330B	#####	0	CO	<input checked="" type="checkbox"/>
3	330F	#####	0	HeS	<input checked="" type="checkbox"/>

1st ALM:      FAULTS: 0      ALARMS: 0

← RADIO SILENT    ↑ RESET    ↓ [Speaker] x    → CHECK

**Note:** Always start the FMC2000 controller first, before starting MeshGuard monitors.

## FMC2000 User's Guide

### 8.2 Turning The FMC2000 Off

1. Unlock the case.
2. Flip the switch located next to the SD card.

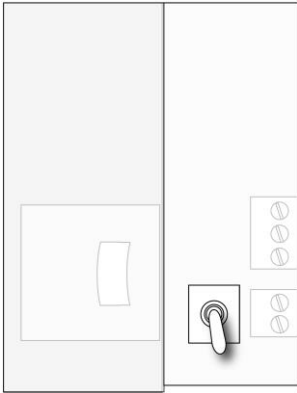

Switch in “off” position

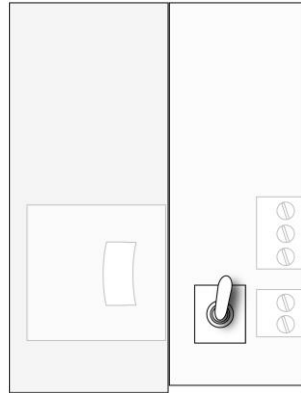

Switch in “on” position

3. Check that the LEDs are no longer glowing. This indicates the FMC2000 is off.

**Note:** After starting or shutting down the FMC2000, we recommend locking the case again to keep dust out, and to prevent tampering by unauthorized personnel.

**Note:** The power supply has no user-serviceable parts.

## 9 Display Information

If remote monitors are connected and sending data to the Controller, each monitor's data is shown in a row with an identification number, radio ID, Station name, sensor value (reading), sensor type, and status (OK checked).

The display shows several status icons at the top: Wireless Status (T<sub>H</sub>), Network Status (tower icon), Datalogging Status (document icon), and Power Type (battery icon). The Date is 10/30 and the Time is 10:30AM.

NO	ID	LOCATION	READING	SENSOR	OK
1	330E	#####	1	CO	<input checked="" type="checkbox"/>
2	330B	#####	0	CO	<input checked="" type="checkbox"/>
3	330F	#####	0	H <sub>2</sub> S	<input type="checkbox"/>

Below the table are three status boxes: 1st ALM: (empty), FAULTS: 0, and ALARMS: 0. At the bottom are five control buttons: RADIO SILENT (left arrow), RESET (up arrow), (down arrow and speaker with X), and CHECK (right arrow).

**Note:** When wireless connectivity to an instrument is lost, the checkbox under the “OK” heading is replaced by this symbol:



















The instrument is not removed from the list. Instead, it drops to the bottom of the list. If connectivity is restored, the checkbox is shown again.













## FMC2000 User's Guide

### 9.1 Display Icons

Icons show active functions and alert you to conditions. The icons used by the FMC2000 include:

Icon	Function
	Datalogging is active
	(Flashing icon) SD card is missing; datalogging stopped
	Detector sensor error
	Detector sensor okay
	Monitor offline
	High alarm
	Low alarm
	Over-range alarm
	Check box
	Select from a list
	Read-only information (cannot be changed)
	Writable parameter
 pinyin	Prompt for inputting simplified Chinese characters
 123	Prompt for inputting numerical data
 abc	Prompt for inputting lower-case letters
 ABC	Prompt for inputting upper-case letters

## FMC2000 User's Guide

	Radio enabled (Host)
	Radio disabled
	FMC2000 is running on AC power
	FMC2000 is running on battery power
	Locks to the selected sensor before checking details (stops automatic updating)
	Unlocks the selected sensor (resumes automatic updating)
	FMC2000 alarm is silenced
	Monitor missing (shows the number of monitors missing from the network, such as "01 OFF," "02 OFF," etc.)
	Data connection via Ethernet is operational.
	Data connection via Ethernet is not operational.
	Indicates MeshGuard Router
	Indicates RAEPPoint wireless relay

# FMC2000 User's Guide

## 10 Navigation

The four “soft-key” buttons shown along the bottom of each screen on the display indicate which buttons to press on the keypad to perform specific functions, including navigation and changing parameters.

In addition to labeled functions, most keys have more than one role. For example, pressing the “1” key while the FMC2000 is monitoring enters the main menus, while pressing the “0” key tells it to perform a system test (this requires a 4-digit password; the default is 1234).

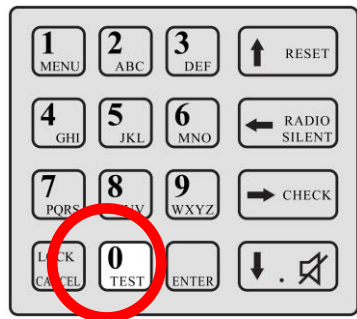
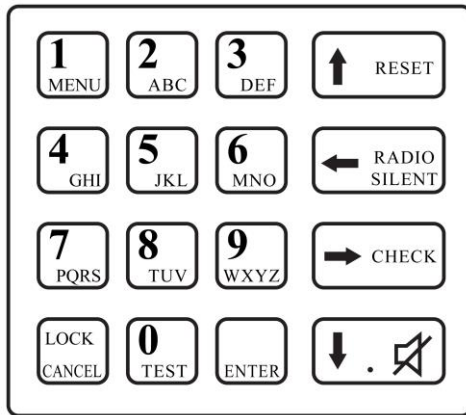

# 11 Normal Operation Mode Controls

From the normal operation screen, you can use the “soft keys” to do the following:

- **Radio Silent.** Turn the radio on or off (enable/disable).
- **Reset.** Reset the system.
- **Alarm Silent.** Silence the alarm.
- **Check.** Get alarm details.



## 11.1 Radio Silent (Enable/Disable)

The radio can be turned off so that it cannot transmit or receive.

1. Press the Radio Silent/left arrow button.  
A warning screen is shown.
2. Enter the 4-digit password (the default is 1234).
3. Press Enter.

The icon changes from the enabled state to the disabled state (see Display Icons, page 26), and the screen button says “Radio Enable” instead of “Radio Silent.” To change the state from disabled back to enabled, follow the same procedure.

## 11.2 Reset

This resets (reboots) the system.

1. Press the Reset/up-arrow button.
2. Enter the 4-digit password (the default is 1234).
3. Press Enter.

The system is now reset

## FMC2000 User's Guide

### 11.3 Silence Alarm

If the system is in alarm, you can silence the local alarm buzzer.

Press the down-arrow/alarm-silence button. The local alarm buzzer is silenced, but the red alarm light continues to flash and the relay continues to act in the state of alarm. If the relay setting is set to latch, a pop-up screen asks if you want to disable the relay. Refer to the relay setting section on page 53 of this guide for more details on setting the relay latch state.

**Note:** If you silence the audio alarm and another alarm message is sent by a MeshGuard in the network, the local alarm buzzer will sound (it is no longer disabled) and the red light flashes.

Also note that that the alarm buzzer and alarm light can be permanently disabled in the configuration menus. Refer to pages 47 and 48 for details.



### 11.4 Check (Alarm Details)

1. Press the Check/right-arrow button.
2. The pop-up screen appears labeled Alarm Detail Info. It contains information about the first alarm.
3. When you are done viewing the screen, press the Check/right arrow button again.
4. If you want to reset the alarm, enter the 4-digit password (the default value is 1234).
5. Press Enter.

This exits the alarm check and returns to the normal operation screen.

**Note:** If you do not want to clear the alarm, skip steps 4 and 5, and press the left-arrow key. The FMC2000 returns to normal monitoring.

# FMC2000 User's Guide

From the Normal Operation Mode main screen, you can enter two different menus, the Main Menu and the Detail Menu. Pressing the keys shown navigates through the menus and submenus. The General Settings, Datalog, and Communication menus are detailed in the Configuration section, starting on page 37.

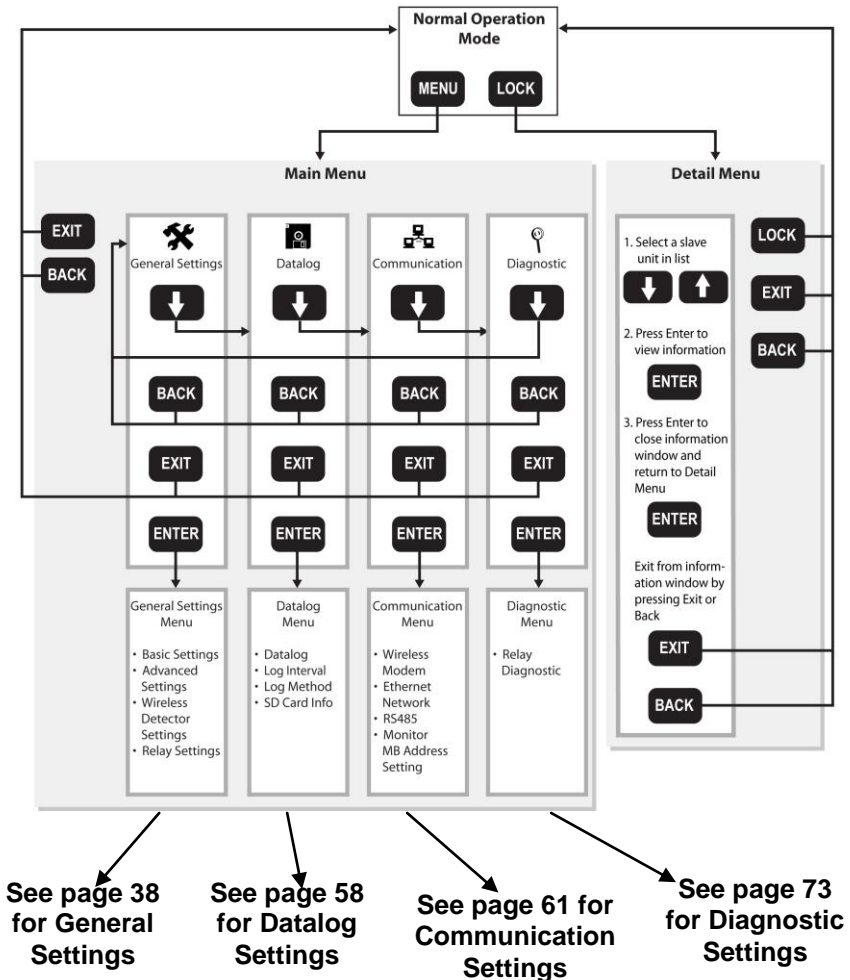

## 11.5 Monitoring

Each monitor on the network is represented by a line of information on the display.

### 11.5.1 Detail Info

You can quickly access a list of the last 10 alarms and the last 10 faults recorded in the FMC2000.

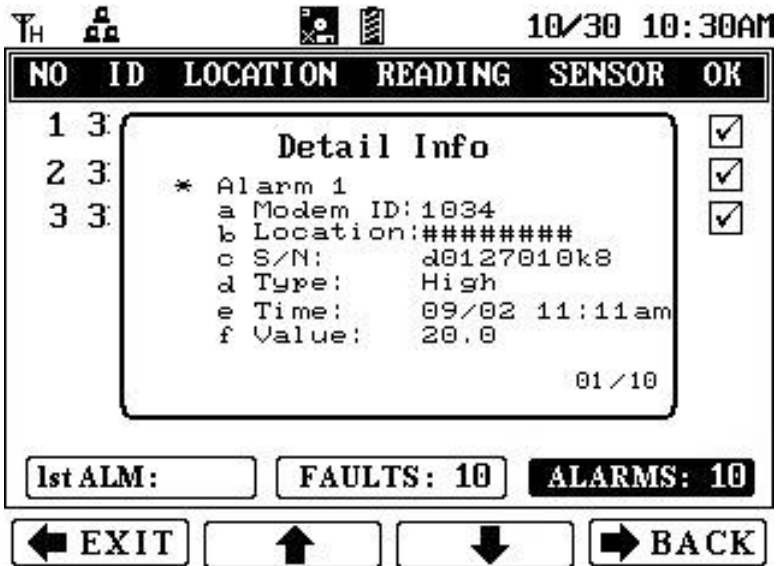

1. Press the right arrow (Check) to select 1st Alarm/Faults/Alarms.
2. Press the right arrow (Check) to highlight Faults or Alarms.
3. Press Enter to see Detail Info.
4. Press the down arrow to scroll through the Fault or Alarms and view detailed information.
5. Press the left arrow to exit.

# FMC2000 User's Guide

## 11.5.2 MeshGuard EC Or LEL

1. Press the Lock button to stop auto-scrolling. The monitor labeled No. 1 (top of the list) is highlighted. The Lock icon appears at the top of the screen.
2. Press the up or down arrow key to select a remote monitor from the list.
3. Press Enter to view the detailed information for that remote monitor. A detail window appears:



4. Press Enter again to close the detail window.

**Note:** Each Detector Detail Info window can have more than one “page.” To step through the pages, press the down arrow key.

## FMC2000 User's Guide

The information in the Detail window for a MeshGuard EC or LEL consists of the following:

- Location
- Serial Number
- Modem ID
- Detector Name
- Detector Battery Capacity
- Sensor
- Alarms
- Last Alarm

(proceeds to second page)

- 1st Sensor
- 1st Sensor Reading
- 1st Sensor Low Alarm (enabled)
- 1st Sensor High Alarm (enabled)
- Last Alarm
- Alarm Time
- Alarm Value

(proceeds to third page)

- 2nd Sensor
- 2nd Sensor Reading
- 2nd Sensor Low Alarm (enabled)
- 2nd Sensor High Alarm (enabled)
- Last Alarm
- Alarm Time
- Alarm Value

## **FMC2000 User's Guide**

### **11.5.3 MeshGuard Router**

The information in the Detail window is less extensive when a MeshGuard Router's data is displayed. It consists of the following:



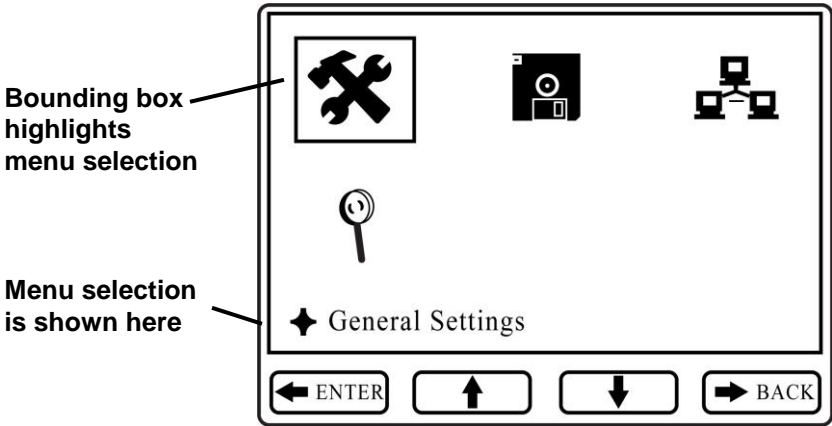

- Location
- Serial Number
- Modem ID
- Detector Name
- Detector Battery Capacity
- Sensor
- Signal

## 12 Configuration

When the controller is in Normal Operation Mode, press the “MENU” key to enter the Configuration menu. You must provide a 4-digit password (the default value is 1234), followed by pressing Enter. The display now looks like this:



The Configuration menus are represented by four icons:

	General Settings
	Datalog Settings
	Communications Settings
	Diagnostic Settings

When the Configuration screen is displayed, the General Settings icon is automatically selected (a bounding box surrounds its icon), and its name is shown on the screen.

“Soft key” indicators along the bottom (Exit, up arrow, down arrow, and Back) show the relationship of functions with the large buttons arranged vertically along the keypad’s right side.

## FMC2000 User's Guide

Press the up or down arrow keys to move from one menu to the next in sequence. The bounding box surrounds each icon in sequence, acting to highlight it, and the text below matches the icon.

Press Exit or Back to exit from the Configuration screen and return to monitoring.

### 13 General Settings Menu

This is the default menu when you enter Configuration. No password is required to enter. It includes the following submenus:

- Basic Settings
- Advanced Settings
- Wireless Detector Settings
- Relay Settings

**To enter:** Press the Enter key.

**To exit:** Press the Exit or Back key.

**To step through the list of submenus:** Press the up arrow or down arrow key.

To select a submenu: Press Enter.



### 13.1 Basic Settings

This menu provides submenus for setting parameters that do not often require changes, but are basic to the FMC2000's operation and datalogging. In addition, information about the FMC2000 is included, such as serial number and firmware version.

Basic settings include:

- Date Format
- Date
- Time Format
- Time
- Language
- Backlight
- Instrument Location
- Serial Number\*
- Firmware Version\*
- Build Date\*
- Build Time\*

\* indicates read-only information.

- Step down through the list on the left side of the display by pressing the down-arrow button.
- Step up through the list by pressing the up-arrow button.

## FMC2000 User's Guide

### 13.2 Date Format

The Date Format allows you to change the way the month, year, and date are indicated. Options include:

<b>Format</b>	<b>Explanation</b>
mm/dd/yyyy	Month, day, 4-digit year
dd/mm/yyyy	Day, month, 4-digit year
yyyy/mm/dd	4-digit year, month, day
mm/dd/yy	Month, day, 2-digit year

1. Press Enter to change the date format.
2. Press the up or down arrow to step through the format options.
3. Press Enter to make and save a selection. Press Back to return to the Basic Settings menu without saving your changes, or press Exit to return to the monitoring screen without saving your changes.

### 13.3 Date

Set the date for the datalogging.

1. Press Enter to edit the date. The first digit is highlighted by a blinking box.
2. Change a number by pressing one of the number keys (0 through 9). To skip a digit, press the down or up arrow.
3. Press Enter to make and save a selection. Press Back to return to the Basic Settings menu without saving your changes, or press Exit to return to the monitoring screen without saving your changes.

## FMC2000 User's Guide

### 13.4 Time Format

The clock can be set to operate in 12-hour or 24-hour mode.

1. Press Enter to change the time format.
2. Press the up or down arrow to step between the format options (12-hour or 24-hour).
3. Press Enter to make and save a selection. Press Back to return to the Basic Settings menu without saving your changes, or press Exit to return to the monitoring screen without saving your changes.

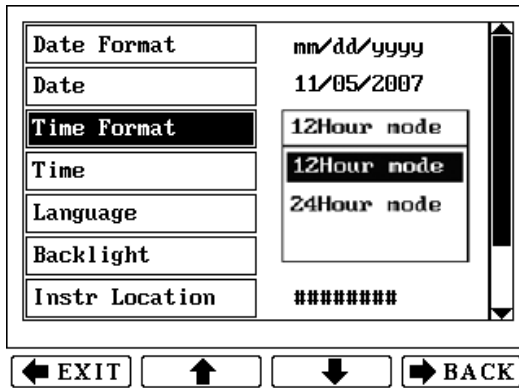

### 13.5 Time

Set the time for the datalogging. The process for changing the time depends on whether the Time Format is set for 12 Hour or 24 Hour mode.

#### To set the time in 12 Hour mode:

1. Press Enter to edit the time. The first digit is highlighted by a blinking box.
2. Change a number by pressing one of the number keys (0 through 9). To skip a digit, press the down or up arrow.

## FMC2000 User's Guide

3. After you have changed the four digits for the time, press Enter to register the time.
4. AM or PM is highlighted by a blinking box. Change AM to PM (or vice versa) by pressing the up or down arrow.
5. Press Enter to make and save a selection. Press Back to return to the Basic Settings menu without saving your changes, or press Exit to return to the monitoring screen without saving your changes.

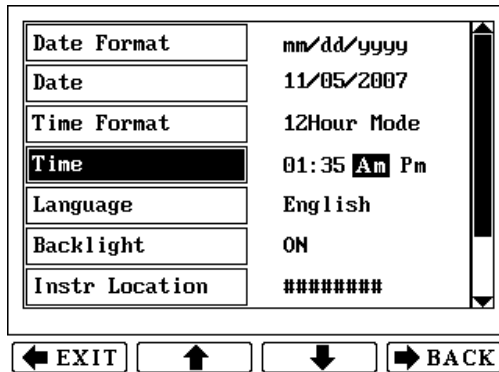

### To set the time in 24 Hour mode:

1. Press Enter to edit the time. The first digit is highlighted by a blinking box.
2. Change a number by pressing one of the number keys (0 through 9). To skip a digit, press the down or up arrow.
3. Press Enter to make and save a selection. Press Back to return to the Basic Settings menu without saving your changes, or press Exit to return to the monitoring screen without saving your changes.

### 13.6 Language

Different languages are supported by the FMC2000, depending on the firmware version. Scroll from English (the default) to other languages.

1. Press Enter to change the language.
2. Press the up or down arrow to step through the language options.
3. Press Enter to make and save a selection. Press Back to return to the Basic Settings menu without saving your changes, or press Exit to return to the monitoring screen without saving your changes.

### 13.7 Backlight

Press Enter to edit the backlight setting. Choices are On and Off.

1. Press Enter to change the backlight to on or off.
2. Press the up or down arrow to step from on to off (or vice versa).
3. Press Enter to make and save a selection. Press Back to return to the Basic Settings menu without saving your changes, or press Exit to return to the monitoring screen without saving your changes.

If the backlight setting is Off, the display's backlight is normally off. Press any key on the keypad to turn on the backlight. If no keys are pressed for 20 seconds, the backlight turns off.

### 13.8 Instrument Location

This tells the location of the FMC2000 controller. You can set this information in the FMC2000 and it is included in the datalog information on the SD card.

1. Press Enter to change the instrument's location.  
**Note:** Press Lock/Cancel to change from upper-case to lower-case letters or to select numerals.
2. Press each letter to be input.
3. When you are done setting the location, press Enter. This exits the Instrument Location setting menu.

### 13.9 Serial Number

This is the FMC2000's serial number. This is a read-only parameter, and it cannot be changed.

### 13.10 Firmware Version

This is the current firmware version operating the FMC2000. This is a read-only parameter, and it cannot be changed.

### 13.11 Build Date

This is the current firmware's build (creation) date. This is a read-only parameter, and it cannot be changed.

### 13.12 Build Time

This is the current firmware's build (creation) time that accompanies the build date. This is a read-only parameter, and it cannot be changed.

# 14 Advanced Settings

Under Advanced Settings, you can change/set passwords and activate the unit's offline alarm. You must use an advanced (6-digit) password to enter.

1. Press Enter.
2. Input the 6-digit advanced password (the default is 123456).
3. Press Enter.
4. Press the up or down arrow to select Basic Password or Advanced Password.

If you want to exit without making changes, press Back to return to the Basic Settings menu, or press Exit to return to the monitoring screen.

## 14.1 Basic Password

The basic password has four digits, and is used when resetting the FMC2000.

To change the basic password:

1. Press Enter.
2. Input the 4-digit password (the default is 1234).
3. Press Enter to make and save a selection. Press Back to return to the Basic Settings menu without saving your changes, or press Exit to return to the monitoring screen without saving your changes.

### 14.2 Advanced Password

The advanced password must have 6 digits. It is used to change controller configurations. **Note:** You must enter advanced settings to change basic password.

To change the advanced password:

1. Press Enter.
2. Input the 6-digit password (the default is 123456).
3. Press Enter to make and save a selection. Press Back to return to the Basic Settings menu without saving your changes, or press Exit to return to the monitoring screen without saving your changes.

### 14.3 Online Monitors

This setting tells the FMC2000 how many monitors the network includes. It sets the minimum number of monitors that the FMC2000 is in communication with. The FMC2000 always knows when monitors go off-line or are moved out of range of the network, and when the number of monitors in the network drops below the minimum set here, a Fault alarm is sounded. The status of each monitor in the network is indicated by one of these symbols:



Monitor is online.



Monitor is offline.

**Note:** The default setting is 0. This tells the FMC2000 to ignore any missing monitors from the network.

To set the number:

1. Press Enter.
2. Input the 6-digit password (the default is 123456).
3. Press down arrow to select Online Monitors.
4. Press Enter.
5. Press number keys to set the number, followed by Enter.



## FMC2000 User's Guide

### 14.4 Delete Monitors Configuration

This allows you to delete the configuration of the monitors. This is important if you are using the FMC2000 with different sets of MeshGuard monitors. By deleting existing configurations, the FMC2000 has more memory space to devote to the new monitors.

1. Press Enter.
2. When you see the “Confirm?” dialog, press Enter to clear the configuration. Otherwise, press Back or Exit.

### 14.5 Delete Relay Configuration

This allows you to delete the configuration of the relays.

1. Press Enter.
2. When you see the “Confirm?” dialog, press Enter to clear the configuration. Otherwise, press Back or Exit.

### 14.6 EchoView

Enable this function to use a RAE Systems Echo View FMC400 in the system's network. Refer to the Echo View manual for details. **Note:** The default value is “Disable.”

1. Press Enter.
2. Select Enable or Disable by using the up and down arrows.
3. Press Enter to lock in your selection and exit the Pager Function menu.

### 14.7 Alarm Buzzer

This sets whether the alarm buzzer sounds when the FMC2000 is in alarm, or is silent.

1. Press the up or down arrow to select Enable or Disable.
2. Press Enter.

### 14.8 Alarm Light

This sets whether the alarm light on top of the FMC2000 glows when the system is in alarm.

1. Press the up or down arrow to select Enable or Disable.
2. Press Enter.

### 14.9 Backup Configuration

This backs up the FMC2000's configuration to the SD card.

Press Enter. The display shows the message, "Confirm?"

Then do one of the following:

- Press Enter to confirm and back up the configuration.
- Press the left arrow to exit.
- Press the right arrow to go back.

### **IMPORTANT!**

You can edit the configuration file and change settings on a PC using a text-editing program. Make sure that the number of characters you use to replace any settings match **EXACTLY** the number of characters you replace. In addition, a file containing settings from one FMC2000 can also be used in other FMC2000s.

### 14.10 Restore Configuration

This restores the configuration saved on the SD card.

### **CAUTION!**

When you restore a configuration from an SD card, all current settings are overwritten and cannot be retrieved.

## FMC2000 User's Guide

Press Enter. The display shows the message, "Confirm?"

Then do one of the following:

- Press Enter to confirm and restore the configuration.
- Press the left arrow to exit.
- Press the right arrow to go back.

### 14.11 Factory Reset

This performs a factory reset, which restores all settings in the FMC2000 to the original settings from the factory. If a factory reset is performed, then all settings you may have programmed are wiped clean and overwritten.

#### **CAUTION!**

A Factory Reset cannot be undone.

Press Enter. The display shows the message, "Confirm?"

Then do one of the following:

- Press Enter to confirm and perform the Factory Reset.
- Press the left arrow to exit.
- Press the right arrow to go back.

## 15 Wireless Detector Settings

Some settings in the FMC2000 can be selected or written, while others can only be read. This table explains the three letters that are shown before each parameter to indicate whether they can be selected, saved, or only read:

Initial	Details
<b>S</b>	Select from a list
<b>R</b>	Read-only (cannot be changed)
<b>W</b>	Writable parameter

## FMC2000 User's Guide

### 15.1 Modem ID

(S) Select the ID of one of the remote monitor's modems so that you can change its detector settings in the FMC2000.

1. Press Enter.
2. Press the up or down arrow to move through the list of IDs.
3. Press Enter to select a Modem ID, or press Back to return to the Wireless Detector Settings menu without saving your changes, or press Exit to return to the monitoring screen without saving your changes.

### 15.2 Location

(W) Set a location name for a monitor in the network.

1. Press Enter.
2. Input a name for the location. A small icon appears that says "ABC." This prompts you to type in a name for the location using the keypad's alphabet keys. Each key has multiple letters, so you may have to press each key a number of times to get the letter you want (for example, press once to get "A," twice to get "B," and three times to get "C").
3. After naming the location, press Enter to make and save a selection. Press Back to return to the Wireless Detector Settings menu without saving your changes, or press Exit to return to the monitoring screen without saving your changes.

### 15.3 Data Interval

(W) Set an interval for the datalog. This can be set between 60 and 600 seconds.

1. Press Enter.
2. Press number keys to enter a new interval.

## FMC2000 User's Guide

3. Press Back to return to the Wireless Detector Settings menu without saving your changes, or press Exit to return to the monitoring screen without saving your changes.

### 15.4 Sensor Type

(R) This tells you the type of sensor in the remote monitor.

### 15.5 Unit

(R) This tells you the measurement unit for the sensor (such as ppm or ppb).

### 15.6 Low

(W) This sets the low alarm point at which an alarm sounds. Changes made to detector settings are wirelessly transmitted to all detectors on the network.

1. Press Enter.
2. Press number keys to enter a new low alarm value.
3. Press Back to return to the Wireless Detector Settings menu without saving your changes, or press Exit to return to the monitoring screen without saving your changes.

### 15.7 High

(W) This sets the high alarm point at which an alarm sounds.

1. Press Enter.
2. Press number keys to enter a new high alarm value.
3. Press Back to return to the Wireless Detector Settings menu without saving your changes, or press Exit to return to the monitoring screen without saving your changes.

### 15.8 STEL

(R) This gives a readout of the STEL value.

### 15.9 TWA

(R) This gives a readout of the TWA value.

### 15.10 Full Scale

(R) N/A

### 15.11 Drift

(R) N/A

### 15.12 Reset LEL

(S) This only applies to a MeshGuard LEL. If the MeshGuard LEL goes over range, you can reset the MeshGuard LEL to normal.

1. Press Enter when you see the warning window.
2. When you see the confirmation window, press Enter.

## **WARNING!**

Before you remotely reset the MeshGuard LEL, make sure that the level of combustible gas(es) is actually below the alarm threshold of the MeshGuard LEL.

## 16 Relay Settings

Each of the five relays has a normally open (NO) and normally closed (NC) switch. The Number 1 relay is dedicated to controlling a Low Alarm state. The other four relays are dedicated to High Alarm states.

**Note:** When a Low Alarm is activated, and then a High Alarm is activated, the Low Alarm continues to be activated as well.

### 16.1 Relay Ratings (Resistive)

**Important!** The relays are not designed for use with high-current/high-inductive loads. These may damage the relays.

Nominal switching capacity: 5A/250 VAC

Maximum switching power: 1,500 VA

Maximum switching voltage: 400 VAC/300VDC

Maximum switching current: 5A (AC)

NO	DON	DOF	LOCK	VOTE	NUM	SLAVEID
1H	0s	0s	OFF	1	2	3562
2L	0s	0s	OFF	1	0	3305
3F	0s	0s	OFF	2	0	
4F	0s	0s	OFF	1	0	

Note: DON - Delay, DOF - Delay Off (0~60sec)  
H - High, L - Low, F - Fault, VOTE - Voting Count

When an alarm is triggered, a relay's switch state is toggled (such as from open to closed). In addition relay switching time can be

## FMC2000 User's Guide

delayed on or delayed off, plus logic can be programmed so that relays only open (or close) when specific multiple monitors go into alarm simultaneously (AND) or when one or more of a specific set of monitors goes into alarm.

Enter programming by pressing ENTER. Step from one column to the next by using the up and down arrows.

### 16.2 Type

This enables each relay to be set as Low, High, or Fault. The relay is only triggered when that specifically programmed type of alarm state occurs.

1. Press Enter. You will see a menu of L, H, F, with the instrument number before it.
2. Press the up or down arrow to select L, H, or F.
3. Press Enter to save the new value.
4. Press the up or down arrow to step to the next or previous column.

### 16.3 DON

Delay On. This is the delay time for the relay switch being activated.

1. Press Enter.
2. Press number keys to enter a new Delay On value (0 to 60 seconds).
3. Press Enter to save the new value.
4. Press the up or down arrow to step to the next or previous column.



## FMC2000 User's Guide

### 16.4 DOF

Delay Off. This is the delay time for the relay switch turning off (returning to its pre-alarm state).

1. Press Enter.
2. Press number keys to enter a new Delay Off value (0 to 60 seconds).
3. Press Enter to save the new value.
4. Press the up or down arrow to step to the next or previous column.

### 16.5 Lock

Lock relay after an action triggered by an alarm condition. When Lock is turned on, the alarm latches after it is triggered.

**Note:** When “Lock” is on, you must enter this menu to turn off a latched alarm.

5. Press Enter. You will see a menu of Off and On.
6. Press the up or down arrow to select Off or On.
7. Press Enter to save the new value.
8. Press the up or down arrow to step to the next or previous column.

## FMC2000 User's Guide

### 16.6 Vote

This enables “voting” for each relay, based on how many monitors are simultaneously in alarm, programming how the relay responds to multiple monitors sending alarm signals.

NO	DON	DOF	LOCK	VOTE	NUM	SLAVEID
1H	0s	0s	OFF	1	2	3562
2L	0s	0s	OFF	1	0	3305
3F	0s	0s	OFF	2	0	
4F	0s	0s	OFF	1	0	

Note: DON - Delay, DOF - Delay Off (0~60sec)  
H - High, L - Low, F - Fault, VOTE - Voting Count

← EXIT   ↑   ↓   → BACK

For example, you can set to trigger an alarm only if two (or three, etc.) monitors are in an alarm state. This is intended to reduce the number of false alarms by ensuring that only when multiple monitors in a physical location send an alarm to the FMC2000, it goes into alarm.

1. Press Enter.
2. With the first line highlighted, press the up or down arrow to select which one you want to edit.
3. Press Enter.
4. Press the down arrow to highlight “Vote”
5. Press Enter.
6. Input a number of instruments.
7. Press Enter to save the new value.
8. Press the up or down arrow to step to the next or previous column.

## FMC2000 User's Guide

### 16.7 Num

Total number included in the logic group. This tells the number of monitors included in the logic group. If "ALL" has been selected, the number representing all of the monitors is shown, rather than an indication of "ALL."

#### **To add a monitor's number (or all):**

1. Press Enter. A menu of selectable remote monitors (their Unit ID is shown) or "ALL" is shown.
2. Press Enter to scroll down.
3. Press the down arrow to highlight a monitor or ALL.
4. Press Enter to add the monitor or ALL to the list in the right column.

#### **To remove a monitor's number (or ALL) from the selected list:**

1. Press Enter. The cursor is on the "T:" (total) header.
2. Press the down arrow. The cursor highlights the top of the second list ("S:").
3. Press Enter to scroll down the list.
4. Make your selection and press Enter to remove it from the column.

### 16.8 Slave ID

This is the monitor's ID. This gives the Monitor ID(s) for each Voting grouping for each of the relays.

1. Press Enter to highlight the relay.
2. Scroll down using the down-arrow key.
3. Press Enter, and a new column appears.
4. Use up and down arrows to select monitors to be included.
5. Press Enter.
6. Press Exit or Back to leave this menu.

### 17 Datalog Settings Menu

This menu offers the following submenu options:

- Datalog
- Log Interval
- Log Method
- SD Card Info

**To enter:** Press the Enter key.

**To exit:** Press the Exit or Back key.

**To step through the list of submenus:** Press the up arrow or down arrow key.

**To select a submenu:** Press Enter.

#### 17.1 Datalog

This shows you with a checkbox whether the FMC2000 is datalogging (storing data). You can manually start or stop the datalogging.

1. Press Enter to highlight the checkbox.
2. Press Enter to make and save a selection. Otherwise, press Back to return to the Datalog menu without saving your changes, or press Exit to return to the monitoring screen without saving your changes.

## FMC2000 User's Guide

### 17.2 Log Interval

To change the Datalog Interval:

1. Press Enter. A box appears, saying "Interval(60~600):"  
This prompts you to input the number of seconds from one datalog point to the next.
2. Set a value by using the number keys on the keypad.
3. Press Enter to make and save a selection. Otherwise, press Back to return to the Datalog menu without saving your changes, or press Exit to return to the monitoring screen without saving your changes.

### 17.3 Log Method

The FMC2000 can save log data either at the log interval you set or only when an alarm event takes place. If you select "Alarm," then a log is only stored when there is an alarm event. This can save a great deal of space on the SD card used to store the data. However, it does not store any other data at any other time.

To change the logging method:

1. Press Enter. The checkbox and accompanying text in the right column is labeled either "Alarm" or "Interval."
2. Change the logging type by pressing Enter until you see the type of logging you want.
3. When you are done, press Back to return to the Datalog menu, or press Exit to return to the monitoring screen.

## FMC2000 User's Guide

### 17.4 SD Card Info

This shows the status of the SD card, if one is installed. If one is installed, the checkbox next to “OK” is checked. If one is not installed, the checkbox next to “No Card” is checked. Status indicators help to alert you to problems:

<b>Alert</b>	<b>Solution</b>
OK	Card is functioning. No action necessary.
No Card	Insert a formatted SD card.
Locked	Remove the SD card and unlock it.
Warning	Warns when SD card data is reaching its capacity.
Full	The SD card is full. Replace it with an empty one.
Need Format	The SD card requires formatting. See instructions on page 96.

Press Back to return to the Datalog menu, or press Exit to return to the monitoring screen.

# 18 Communications Menu

This menu sets the parameters for connection. This menu requires an advanced (6-digit) password for entry.

- Wireless Modem
- Ethernet Network
- RS485
- Monitor MB Address Setting

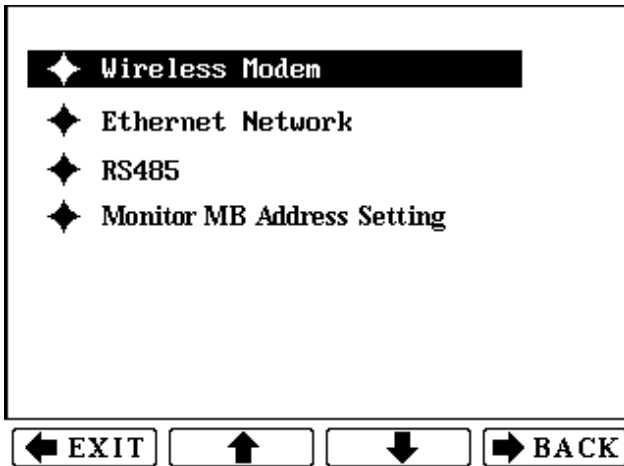

**To enter:** Press the Enter key. Input the 6-digit password. Press Enter again.

**To exit:** Press the Exit or Back key.

**To step through the list of submenus:** Press the up arrow or down arrow key.

**To select a submenu:** Press Enter.

## FMC2000 User's Guide

**To exit:** Press Back to return to the Communications menu, or press Exit to return to the monitoring screen without saving your changes.

### 18.1 Wireless Modem

To enter Wireless Modem settings:

1. Input the 6-digit advanced password.
2. Press Enter. The menu appears.
3. Step through the menu choices by using the up and down arrows.
4. Select a menu choice by pressing Enter. Otherwise, press Back to return to the Wireless Modem menu without making changes, or press Exit to return to the monitoring screen.

#### 18.1.1 Form a Network

The FMC2000 automatically forms a network under a single PAN ID. The controller radio picks up the cleanest channel by scanning radio channels. To ensure the best communication signal strength, use this procedure when you set up a network for the first time, or if you reconfigure the network.

1. Press Enter. A box appears with the message "Confirm?"
2. Press Enter to make and save a selection. Otherwise, press Back to return to the Wireless Modem menu without saving your changes, or press Exit to return to the monitoring screen without saving your changes.

#### 18.1.2 Radio Synch

The FMC2000 sends a radio synchronization command to bind the detectors to the controller within the same network.

When this is on, the monitors in a network synchronize with the FMC2000. Therefore, when a message is sent by a monitor to the



## FMC2000 User's Guide

FMC2000, it sends an acknowledgement that it received the message back to the monitor.

The FMC2000 can check this synchronization once or at intervals. The one-time check is called "Sysch," while the others are labeled by their time intervals of 10, 20, and 30 minutes.

1. Press Enter. Four check boxes are shown:  
    Synch  
    Auto:  
        10Min  
        20Min  
        30Min
2. Press the down arrow to step through the options. The check mark shows in the selected box.
3. Once your selection is made, press Exit or Back.

### 18.1.3 Radio PanID

Set the wireless Pan ID. The current Pan ID is shown.

To change the Pan ID:

1. Press Enter. A box appears, saying "PanID(0~999):" This prompts you to set a Pan ID number.
2. Set a Pan ID number using the number keys on the keypad.
3. Press Enter to make and save a selection. Otherwise, press Back to return to the Wireless Modem menu without saving your changes, or press Exit to return to the monitoring screen without saving your changes.

### **IMPORTANT!**

Make sure all monitors in the network have the same Pan ID number in order to communicate within the network. If you change the Pan ID number on the FMC2000, make sure you check the other Pan IDs.

## FMC2000 User's Guide

### 18.1.4 Del Binding

This deletes the radio binding list. Use this when you remove monitors from the network in order to keep the FMC2000 from looking for monitors removed from service, and to allow more free space for adding new monitors.

1. Press Enter. A box appears with the message "Confirm?"
2. Press Enter to make and save a selection. Otherwise, press Back to return to the Wireless Modem menu without saving your changes, or press Exit to return to the monitoring screen without saving your changes.

### 18.1.5 Channel

This tells you the current channel that the network is operating on.

- 900MHz models use channels 0 to 10
- 2.4GHz models use channels 11 to 26

### 18.1.6 Ping Network

Pinging sends a signal to the units on the network. When a unit receives a ping signal, it alarms once. This tests the radio connection between the FMC2000 and other units on its network.

There are two pinging options:

- Ping NTW
- Auto Ping: 10 Seconds

Ping NTW (network) sends a ping signal to all the units on the network one time. Auto Ping automatically sends a ping signal once every 10 seconds until pinging is turned off at the FMC2000.

### 18.2 Ethernet Network

The FMC2000 can be connected to a network via Ethernet. This requires using an Ethernet cable with an RJ-45 connector, plugged into the port on the upper circuit board. The other end can be plugged into a hub, router, or other access point to a network or to the Internet. Communication is through the TCP/IP network protocol.

To enter Ethernet settings:

1. Input the 6-digit advanced password.
2. Press Enter. The menu appears.
3. Step through the menu choices by using the up and down arrows.
4. Select a menu choice by pressing Enter. Otherwise, press Back to return to the Ethernet menu without making changes, or press Exit to return to the monitoring screen.

The Ethernet menu includes:

- TCPIP Enable
- Protocol Select
- Server IP
- Server Port
- Client IP
- Subnet Mask
- Default Gateway
- Re-Obtain IP
- Client MAC

#### 18.2.1 TCPIP Enable

In order for the TCP/IP connection to operate, it must be enabled (by default, it is disabled). Because using TCP/IP increases

## **FMC2000 User's Guide**

overhead to the system, it is recommended that you disable TCP/IP if you are not using it.

There are only two options, Enable and Disable. Change the setting in the following way:

1. Press Enter.
2. Press Up or Down to select Enable or Disable.
3. Press Enter.

### **18.2.2 Protocol Select**

Two different protocols for Ethernet data transmission are available. The options are RCS and Modbus.

To change the setting:

1. Press Enter.
2. Press Up or Down to select RCS or Modbus.
3. Press Enter.

## FMC2000 User's Guide

### 18.2.3 Server IP

Input the IP address of your system's server that the FMC2000 is connecting to, if you know it. Check with your IT department for guidance on setting IP addresses for your system within a network.

Number such as 172.18.12.81.

1. Press Enter
2. Press a digit (1 through 9). After each number is input, it advances to next digit.
3. When the IP address has been input, press Enter.

### 18.2.4 Server Port

Set the appropriate port for your TCP/IP to match your system (for example, 9723). Check with your IT department for guidance on server port settings.

To set the Server Port:

1. Press Enter.
2. Input a Server Port number (make sure the numbers you choose are not blocked by your network's firewall).
3. Press Enter.

### 18.2.5 Client IP

The Client IP address is the address of the FMC2000 controller. An IP address is used by individuals and Internet applications to reach a specific computer. IP addresses consist of four sets of numbers separated by periods. For example, you might use a number such as 172.18.12.81.

## FMC2000 User's Guide

If necessary, check with your IT department for guidance on setting a Client IP address to be used within a network.

To set the Client IP address:

1. Press Enter
2. Press a digit (1 through 9). After each number it advances to next digit.
3. When the IP address has been input, press Enter.

### 18.2.6 Subnet Mask

A subnet mask is used to identify a network within the larger network. An example of a subnet mask is a number such as 255.255.255.0. Note that periods separate each of the four sets of numbers.

Check with your IT department for guidance on setting a subnet mask for your network.

To set the Subnet Mask:

1. Press Enter
2. Press a digit (1 through 9). After each number it advances to next digit.
3. When the IP address has been input, press Enter.

### 18.2.7 Dflt Gateway

A default gateway is a node (a router) on a computer network that serves as an access point to another network. Each Default Gateway is defined by a number such as 172.18.12.81. Note the periods between the four sets of numbers.

## FMC2000 User's Guide

Check with your IT department for guidance on setting a Default Gateway.

To set your Default Gateway:

1. Press Enter
2. Press a digit (1 through 9). After each number it advances to next digit.
3. When the IP address has been input, press Enter.

### 18.2.8 Re-Obtain IP

This sets the IP address for the controller automatically through DHCP (dynamic host configuration protocol).

Check with your IT department before re-obtaining an IP address if your system is operating within a larger system.

To re-obtain the IP address:

1. Press Enter.
2. When you see “Confirm?” press Enter to confirm. Otherwise, to leave unchanged, press Back.

### 18.2.9 Client MAC

A MAC (Media Access Control) address is an address used to represent hardware devices on an Ethernet network. Each MAC address is unique. An example of a MAC address is 00-13-20-80-15-80.

**Note:** You cannot change the FMC2000's Client MAC address.

## FMC2000 User's Guide

### 18.3 RS485

This setting configures the RS485 port so that data can be transferred at the correct rate, in the desired format, and with proper identification.

Entering this menu requires using a 6-digit advanced password.

1. Input the 6-digit advanced password.
2. Press Enter. The menu appears, showing the selectable settings for RS-485:
  - Baud Rate
  - Client ID
  - MB Type
  - Protocol
  - Monitor Address
3. Step through the menu choices by using the up and down arrows.
4. Select a menu choice by pressing Enter. Otherwise, press Back to return to the RS-485 menu without making changes, or press Exit to return to the monitoring screen.

#### 18.3.1 Baud Rate

The Baud Rate is the transmission rate at which data flows between computers. The baud rate is roughly equivalent to the number of bits per second (bps). For proper data transfer, the baud rate must be the same at the transmitting and receiving ends of a connection.

Options for the FMC2000 are 4800, 9600, 19200 baud. The default value is 19200.



## FMC2000 User's Guide

**Note:** Always compare baud rates at the sending and receiving ends. If they are the same but data is dropped, try a lower setting. Check with your IT department for further guidance on setting baud rates.

To set the Baud Rate:

1. Press Enter
2. Use the Up and Down arrows to select a baud rate.
3. Press Enter.

### 18.3.2 Client ID

When setting up RS-485 connections according to the Modbus protocol, a unique Client ID is necessary.

To set the Client ID:

1. Press Enter
2. Input a number from 1 to 246.
3. Press Enter.

### 18.3.3 MB Type

MB Type is short for “Modbus Type.” There are two variants for Modbus serial connections, RTU and ASCII. Each represents numerical data using slightly different protocol details. Modbus RTU is a compact, binary representation of the data. Modbus ASCII is human readable, and more verbose. The RTU format follows the commands/data with a cyclic redundancy check (CRC) checksum, while the ASCII format uses a longitudinal redundancy check checksum. Important: Nodes configured for the RTU variant do not communicate with nodes set for ASCII, and vice versa.

1. Use the up and down arrows to select either RTU or ASCII.
2. Press Enter.

**Note:** For detailed technical reference material covering the FMC2000's ModBus implementation, see Appendix G, beginning on page 102.

## FMC2000 User's Guide

### 18.3.4 Protocol

Choose a communications protocol for the FMC2000 communications with other equipment. Options are: Modbus or RCS (RAE Communications System).

1. Use up and down arrow to select either MODBUS or RCS.
2. Press Enter.

### 18.3.5 Monitor Address

You can choose two types of Monitor Address: Static or Dynamic. This makes it easier in some cases to integrate data from into existing non-FMC2000 systems.

**Dynamic:** Links the Modbus output to the ID of the instrument communicating with the FMC2000 (for example, 15A8, etc.).

**Static:** Links ModBus output to the unit number in the leftmost column of the main display (1, 2, 3, 4, etc.).

When the Static option is set, if an instrument goes into alarm, it maintains its status as 1, 2, 3, 4, etc., as configured, rather than changing. Also, when using Static ModBus, you must assign each instrument ID to a static number.

NO	ID
1	3360
2	3562
3	3395
4	330D
5	33ED
6	3768
7	3456
8	3E04

← EXIT   ↑   ↓   → BACK

**Note:** Dynamic is the factory default state.

1. Use the up and down arrows to select either MODBUS or RCS.
2. Press Enter.

## 19 Diagnostic Menu

The Diagnostic menu consists of a Relay Diagnostic operation screen, where you can test the relays in the FMC2000.

### 19.1 Relay Output Diagnostic

To access the relay tests:

1. Press Enter.
2. Input the 6-digit advanced password.
3. Press Enter. The relay test screen appears, showing the four relays (named Relay 1 through Relay 4):

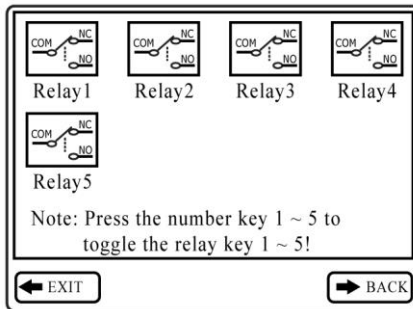

Press 1, 2, 3, 4, or 5 on the keypad to toggle the state of the corresponding relay from closed to open and vice versa. Notice that the schematic drawing of the relay changes from “NC” to “NO” and vice versa each time you press the key.

## FMC2000 User's Guide



Relay1



Relay1



Relay1



In addition, you can hear the relay click, which tells you that the relay is changing state.

4. Exit and return to the main reading screen by pressing Exit, or go back to the previous screen by pressing Back.

## 20 Transferring Data From The SD Card

The data stored on the SD card (part number 550-0300-000) in the FMC2000 is in standard ASCII text format, making it easy to import into most spreadsheet and word-processing programs. In addition, it is in CSV (comma-separated value) form, so that it can be easily put into existing spreadsheets (such as Microsoft Excel<sup>®</sup>) or into columns in word-processing programs.

Some computers and external hard drives have ports that accept SD cards directly. For computers that do not have an SD port, inexpensive converters designed to accept an SD card and plug into a USB input are widely available (at electronics stores, camera stores, etc.).

Follow this procedure for removing the SD card from the FMC2000 and connecting it to a computer for data transfer:

1. Turn off the FMC2000 or place it in Standby mode.
2. Remove the SD Card by pressing in and letting it eject.

### WARNING!

Do not remove the SD card during operation. Data may be lost or corrupted.

Place the SD Card into the adapter.

Place the SD card into an adapter and plug it into the USB port of a computer.

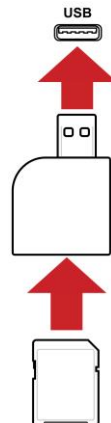

## FMC2000 User's Guide

Once the SD card is in the adapter and connected to the computer, it should show up as an external device or a drive.

1. Double-click the My Computer icon on your desktop.



When it opens, you should see a list of drives, including your C: drive, where most programs reside, and the external device holding the SD card.



2. Double-click on the name of the device to open its directory. You now see a folders containing a file created by the FMC2000.
3. Create a folder on your computer.
4. Use your mouse to drag the file into that folder.

# 21 After Transferring Data From The SD Card

Once you have transferred the files from the SD card to your computer, you can open them in a spreadsheet program (such as Microsoft Excel) or in a word-processing program (such as Microsoft Word). You should open them as soon as possible to make sure that all of the data transferred properly and was not corrupted.

**Note:** Do not use the SD card for other functions (such as storing images from a digital camera) and do not modify the record and save it again on the SD card. Also, if you are using multiple FMC2000 controllers, an SD card should be dedicated to only one FMC2000.

You can place the SD card back into the FMC2000 and resume collecting data. New files will not overwrite old ones.

If the SD card is full, or you want to retain it as a physical archive for future reference or backup, you can replace it with any SD card. Typically, 1GB is a good minimum size. The FMC2000 can accept SD cards with capacities up to 2GB (providing storage for up to 3 years with 24 monitors). When keeping an SD card for long-term storage, it is a good idea to lock the card (move the tab on the left side of the card to the “locked” position). This ensures that if it is put into a computer or FMC2000, data cannot be written to it.

## FMC2000 User's Guide

Another option is to erase the SD card. To erase the data, follow these steps:

1. Make sure the locking tab on the SD card is in the “unlocked” position.
2. Insert it into the computer or the adapter (and plug that into the computer).
3. Once the SD card is in the adapter and connected to the computer, it should show up as an external device or a drive.
4. Double-click the My Computer icon on your desktop.



5. When it opens, you should see a list of drives, including your C: drive, and the SD card (shown as a device).
6. Double-click on the name of the device to open its directory. You now see a list containing files.
7. Select and drag all the files to the trash. Alternatively, you can select the files, right-click with your mouse, and select Delete.



## 22 Maintenance

The major maintenance items of the FMC2000 are:

- Battery
- SD Card

**Note:** Maintenance should be performed by qualified personnel only.

**Note:** The printed circuit board of the instrument is connected to the battery pack even if the power is turned off. Therefore, it is very important to disconnect the battery pack before servicing or replacing any components inside the instrument. Severe damage to the printed circuit board or battery may occur if the battery is not disconnected before servicing the unit.

### 22.1 Battery Charging & Replacement

A fully charged battery runs the FMC2000 for up to 15 hours continuously. The charging time is less than 8 hours for a fully discharged battery. If the 12-volt lead-acid battery is old and does not hold a charge, replace it with a new one, part number 500-0132-000. Be sure to observe the “+” and “-” polarity orientation when connecting the battery.

### 22.2 SD Card Replacement

Follow the instructions on page 14 for replacing an SD card.

### 22.3 Special Servicing Note

If the instrument needs to be serviced, contact either:  
The RAE Systems distributor from whom the instrument was purchased; they will return the instrument on your behalf.

or

The RAE Systems Technical Service Department. Before returning the instrument for service or repair, obtain a Returned Material Authorization (RMA) number for proper tracking of your equipment. This number needs to be on all documentation and posted on the outside of the box in which the instrument is returned for service or upgrade. Packages without RMA Numbers will be refused at the factory.

## 23 Troubleshooting

Problem	Possible Reasons & Solutions
<p>Battery backup cannot power the FMC2000 after the main AC power is disconnected</p>	<p><b>Reasons:</b> Battery hardware switch is turned off. Discharged battery. Defective battery.</p> <p><b>Solutions:</b> Turn off the FMC2000, and turn it on again using its power switch. Make sure main power is connected and turned on. Charge or replace battery.</p>
<p>Lost password</p>	<p><b>Solutions:</b> Call Technical Support at +1 408-752-0723 or toll-free at +1 888-723-4800</p>
<p>Buzzer Inoperative</p>	<p><b>Reasons:</b> Bad buzzer.</p> <p><b>Solutions:</b> Check that buzzer is not turned off. Call authorized service center.</p>
<p>FMC2000 cannot receive and display monitor(s)</p>	<p><b>Reasons:</b> PAN IDs do not match. FMC2000 is too far from the monitor(s).</p> <p><b>Solutions:</b> Check PAN IDs. Controller should be closer to the monitor(s). Press [Y/+] on the MeshGuard.</p>

## FMC2000 User's Guide

<p>Relay(s) not functioning</p>	<p><b>Reasons:</b> Wiring to relay may be incorrect. Relay settings may be incorrect. Relay may be damaged or defective.</p> <p><b>Solutions:</b> Check wiring, including at alarm or other connected equipment. Check Relay Settings. Use continuity tester or voltmeter to check relay (use procedure outlined in Appendix B).</p>
---------------------------------	--

## **24 Technical Support**

To contact RAE Systems Technical Support Team:

Monday through Friday, 7:00AM to 5:00PM Pacific (US) Time

Phone (toll-free): +1 888-723-4800

Phone: +1 408-952-8461

Email: [tech@raesystems.com](mailto:tech@raesystems.com)

## **25 RAE Systems Contacts**

### **RAE Systems**

#### **World Headquarters**

3775 N. First St.

San Jose, CA 95134-1708 USA

Phone: +1 408.952.8200

Fax: +1 408.952.8480

**E-mail:** [customerserv@raesystems.com](mailto:customerserv@raesystems.com)

**Web Site:** [www.raesystems.com](http://www.raesystems.com)

### **RAE Systems Technical Support**

Monday through Friday, 7:00AM to 5:00PM Pacific Time

Phone: +1.408.952.8461

Email: [tech@raesystems.com](mailto:tech@raesystems.com)

### **EMEI Headquarters**

Life Safety Distribution AG

Javastrasse 2

8604 Hegnau, Switzerland

**Phone:** +41 (0)44 943 4300

**Fax:** +41 (0)44 943 4398

**Email:** [haexpert@honeywell.com](mailto:haexpert@honeywell.com)

## FMC2000 User's Guide

### **RAE Systems France**

ZI des Ayats

679390 MILLERY

France

**Phone:** +33 4 78 46 16 65

**Fax:** +33 4 78 46 25 98

**Email:** info-france@raeeurope.com

**Web:** www.raesystems.fr

### **RAE BeNeLux BV**

Hoofdweg 34C

2908 LC Capelle a/d IJssel

The Netherlands

**Phone:** +31 10 4426149

**Fax:** +31 10 4426148

**Email:** info@rae.nl

**Web:** www.rae.nl

### **RAE Systems Spain, s.l.**

Av. Remolar, 31

08820 El Prat de Llobregat

Spain

**Phone:** +34 933 788 352

**Fax:** +34 933 788 353

**Email:** info@raespain.com

**Web:** www.raespain.com

### **RAE Systems (Hong Kong) Ltd.**

Units 1516-18, 15/F, Delta House, 3 On Yiu Street

Shatin, NT, Hong Kong

**Phone:** +852.9.133.6225

**Fax:** +852.2.669.0803

**Email:** hksales@raesystems.com

## FMC2000 User's Guide

### **RAE Systems Japan**

1-20-19-608 Higashinakajima Higashiyodogawa-ku

Osaka 533-0033, Japan

**Phone:** +81.6.6325.7660

**Fax:** +81.6.6325.7662

**Email:** [jpsales@raesystems.com](mailto:jpsales@raesystems.com)

### **RAE Systems Korea**

101-1301, Bucheon TechnoPark III, SamJungDong 36-1,

Oh Jung-Gu, Bucheon-Si, Gyeong Gi-Do

Korea 421-741

**Phone:** +82.32.624.0460

**Fax:** +82.32.624.0463

**Email:** [krsales@raesystems.com](mailto:krsales@raesystems.com)



## 26 Appendix A: Wiring The FMC2000

Follow local ordinances when wiring the FMC2000 for AC power.

### 26.1 DC Wiring

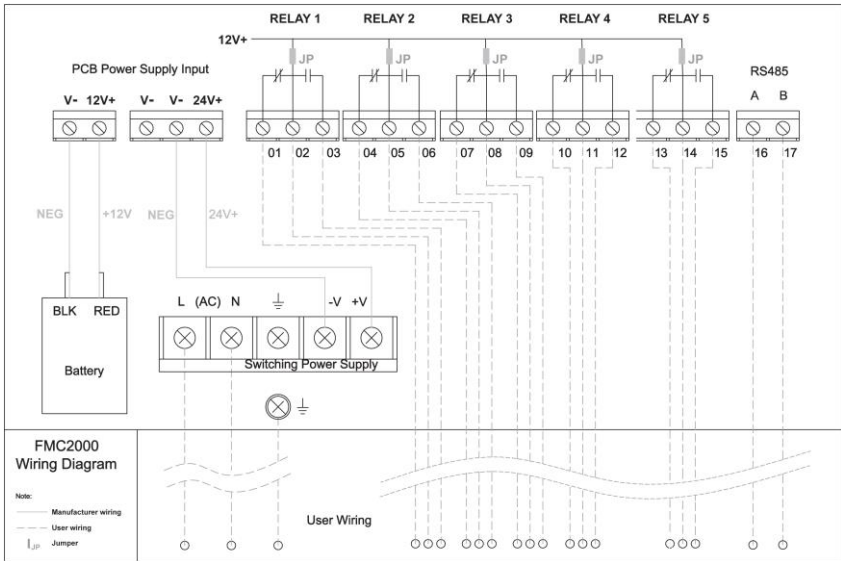

### 26.2 AC wiring

L N  $\perp$  V- V+

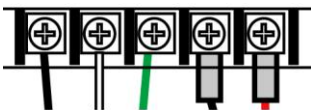

# 27 Appendix B: Wiring The FMC2000 To External Alarms

The five relays are wired for NO (normally open) and NC (normally closed) operation.

### **IMPORTANT!**

Read this before wiring a RAEPPoint to control external customized loads.

1. Before wiring a RAEPPoint to control external devices, consult the datasheet that applies to the RAEPPoint's relays: [http://www3.panasonic.biz/ac/e/control/relay/cautions\\_use/index.jsp#ANCHOR3](http://www3.panasonic.biz/ac/e/control/relay/cautions_use/index.jsp#ANCHOR3)
2. Some none-resistive loads, such as motors, horns, or strobes, may present high inrush current, causing relay contact degradation/welding even they are within the relays' rating. A simple solution is to place an NTC thermistor (for example, model B57236S0509M0\*\* from EPCOS) in series between the relay and the load, to limit inrush current.

# FMC2000 User's Guide





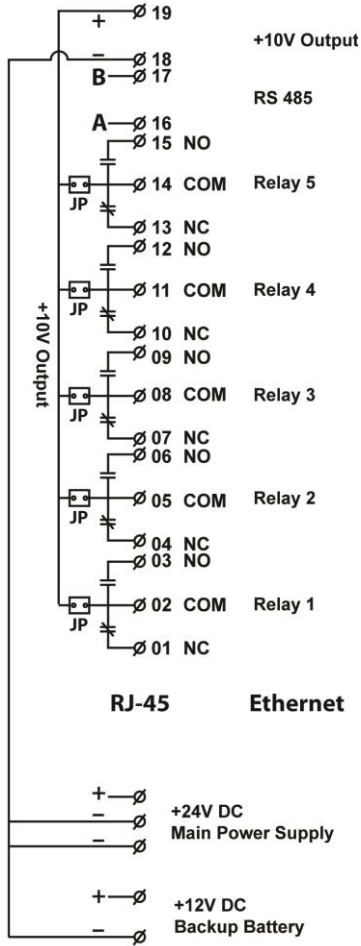

## 27.1 Wiring Blocks In The FMC2000

(The schematic below is included inside the FMC2000.)



# FMC2000 User's Guide

Explanation of wiring blocks:

	19 + 18 -	10V Output	10V output provides 10 VDC @ 2A
	17 B 16 A	RS 485	RS-485 data output
	15 NO 14 COM 13 NC	RELAY 5	Relays 2, 3, 4, and 5 are for High Alarm
	12 NO 11 COM 10 NC	RELAY 4	
	9 NO 8 COM 7 NC	RELAY 3	
	6 NO 5 COM 4 NC	RELAY 2	
	3 NO 2 COM 1 NC	RELAY 1	

## 27.2 Relay Electrical Drawing

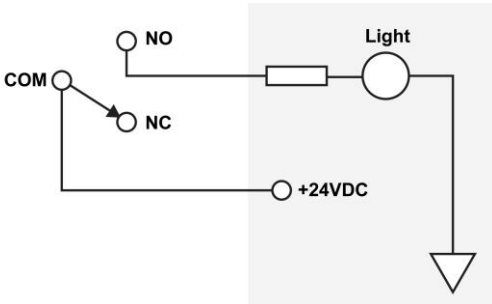

## 27.3 Checking Relay Continuity

Each relay has a common terminal and a normally open (NO) and normally closed (NC) terminal. Use a continuity tester or voltmeter (set to measure resistance) to check the relay's activity.

1. Enter the Relay Diagnostic menu. Press Enter, followed by the password (the default is 123456).

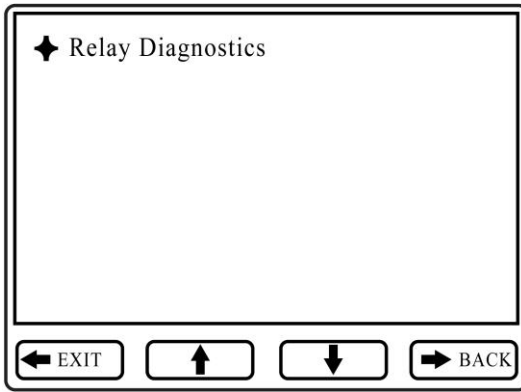

2. Touch the probes of a continuity tester or voltmeter to the NO and COM terminals on the relay's relay block inside the FMC2000.

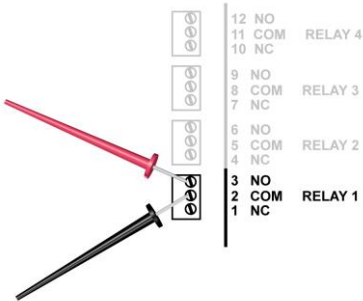

**Testing continuity of Normally Open portion of relay.**

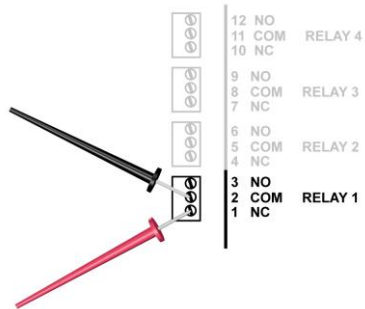

**Testing continuity of Normally Closed portion of relay.**

## FMC2000 User's Guide

3. In the Relay Diagnostic menu, toggle the relay by pressing the keypad's corresponding key (1, 2, 3, 4, 5).

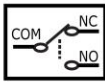

Relay1

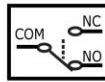

Relay1

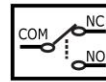

Relay1

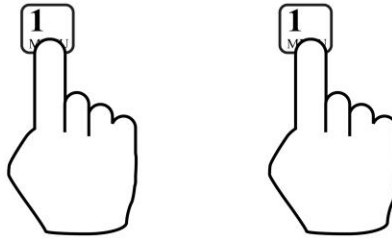

4. Touch the probes to the NC and COM terminals on the relay block.
5. Again, toggle the relay by pressing the corresponding key on the keypad.

Each time you press the key, the continuity tester or voltmeter should show that the relay has changed from open to closed (or vice versa). If this change does not occur, then the relay may be damaged and require replacement. Contact RAE Systems Customer Support.

### 27.3.1 Power Supply Connections

Although the connections are shown on the diagram, and there are connection points, the power supply should only be used for charging the backup battery and powering the FMC2000.

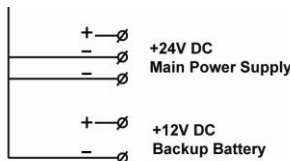

# FMC2000 User's Guide

## 27.3.2 Dry Contact Operation

The five relays are pre-configured as powered contacts, with 10VDC. Any or all of the relays can have power removed for “dry-contact” operation. For dry-contact operation, remove the jumpers (labeled “JP”) located adjacent to each connection block. To remove a jumper, pull it straight up.

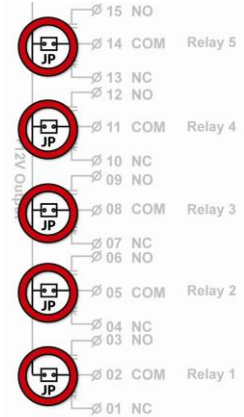

## 28 Appendix C: Connecting RS485 (Modbus)

Follow standard Modbus procedures when connecting the FMC2000 via RS-485. Wires should be connected to points 16 and 17.

**Note:** Configuration must be done in the menus of the FMC2000 for proper operation.



## FMC2000 User's Guide

In addition, on the main PC board, switches S2, S4, and S5 must be set to RS485. (These three switches are located near the wireless communications module.)

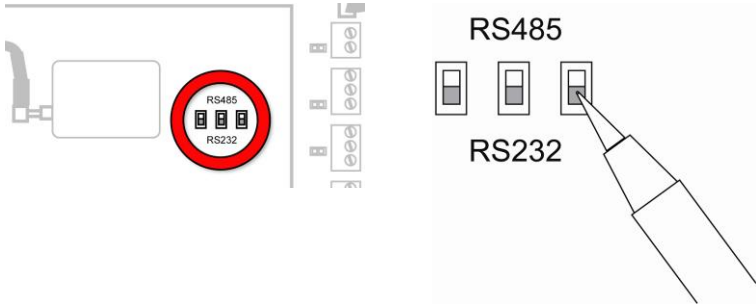

Use a pen or jeweler's screwdriver to push the switch handles to the "RS485" position.

## 29 Appendix D: Connecting Ethernet

Connecting the FMC2000 to a network via Ethernet requires plugging an Ethernet-compatible cable (typically, an RJ-45 connector on Cat-5 cable) into the Ethernet port on the upper PC board and then configuring the IP address, data type, etc. This may require consulting your Information Technology support, depending on the type of network you are connecting to.

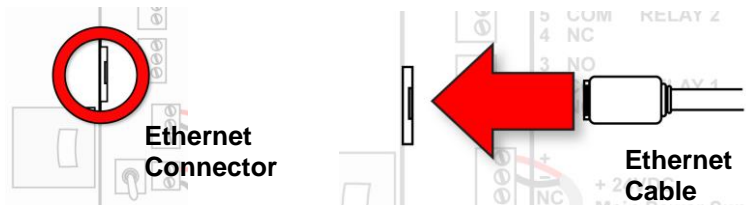



### 30 Appendix E: Connecting to a Light/Alarm Bar

The FMC2000 has a multi-pin connector on the bottom that is designed for connection with a RAE Systems FA-200 Light/Alarm Bar. The internal wires from the connector are prewired to the NO (Normally Open) connection points on the five relay wiring blocks.

**Note:** Pin F connects to Ground. Pins B, C, D, and E transmit 10V @ 2A power when an alarm occurs.

#### Connector Pin Layout

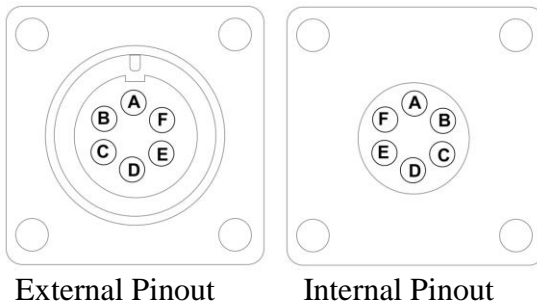

**Pin A:** No connection

**Pin B:** Relay 1

**Pin C:** Relay 2

**Pin D:** Relay 3

**Pin E:** Relay 4

**Pin F:** Ground

**Note:** If an external device is not connected, keep the dust cap on the connector to protect the pins.

## 31 Appendix F: Formatting An SD Card For FAT32

SD cards typically come pre-formatted by the manufacturer, but for an SD card to operate properly in the FMC2000, it must be formatted for FAT32, a 32-bit file allocation system. If the card is formatted for FAT or FAT16 or unformatted, it must be formatted for FAT32.

Before using an SD card or checking whether it needs formatting, make sure that its lock tab is in the “unlocked” position.

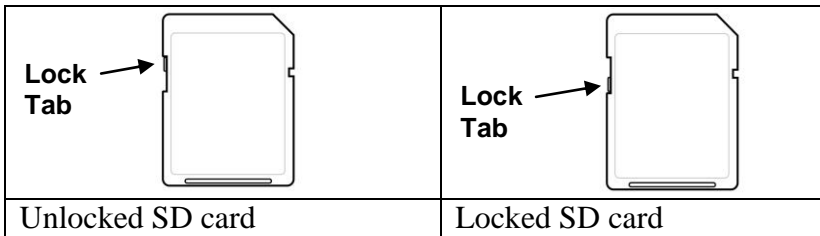

### 31.1 Formatting An SD card

#### **WARNING!**

Formatting an SD card erases everything on the card. Once an SD card is formatted, any contents that were on it cannot be recovered. Always make a backup of the data on an SD card before reformatting it.

## FMC2000 User's Guide

1. Make sure the SD card is not locked.
2. Place the SD card into an adapter and connect it to a computer's USB port (some computers have a card slot and do not require an adapter).

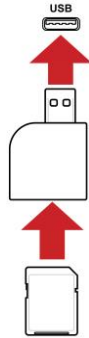

**Place the SD card into an adapter and plug it into the USB port of a computer.**

3. Double-click the “My Computer” icon on the computer's desktop.



The list of Devices with Removable Storage should include your SD card with a title of “Removable Disk.”



## FMC2000 User's Guide

4. Right-click on the Removable Disk item to get details about it:

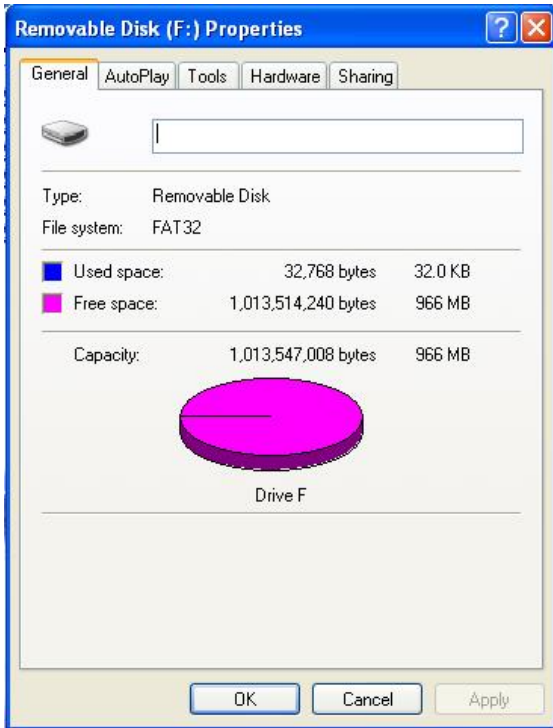

If the file system says “FAT 32,” then you can click OK and use (or continue to use) the disk. If the disk is formatted for any other file system (FAT or FAT 16, for example), you should reformat it for FAT 32.

**Note:** If the disk is formatted for FAT 32 and you simply want to reformat the disk, follow the steps outlined below, as if it were a new disk or one that is formatted for another file system.

## FMC2000 User's Guide

5. Click OK to close the dialog box.
6. Right-click on “Format...”

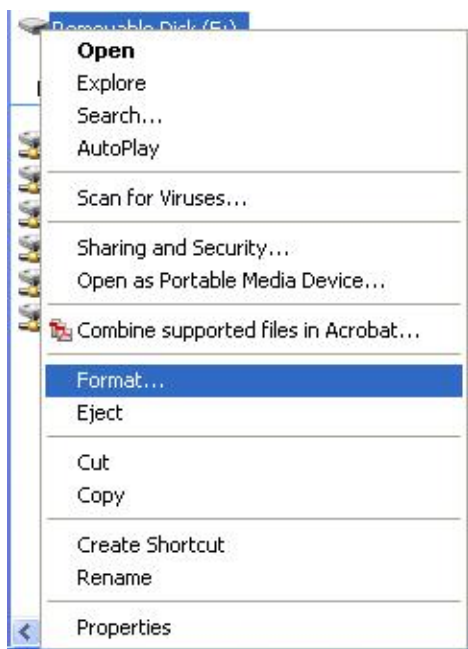

## FMC2000 User's Guide

7. Under “File System,” select “FAT 32.”

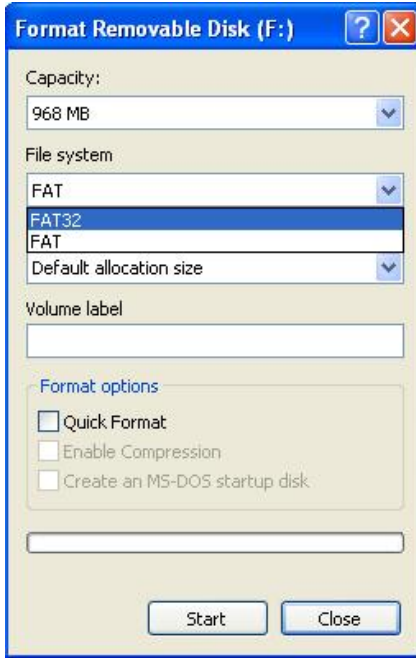

8. Click “Start.” (It does not matter whether you select “Quick Format,” so leave it unchecked.)
9. A pop-up window warns you that everything on the disk will be erased during formatting. If you do not want to continue with the formatting operation, click “Cancel.” Otherwise, click “OK.”

## FMC2000 User's Guide



Formatting should take less than one minute. When the operation is complete, you see this message:



10. Click "OK." The SD card can now be used in the FMC2000. Remove it and place it in the FMC2000.

# 32 Appendix G: ModBus Protocol For The FMC2000

## 32.1 Overview

This document describes the ModBus protocol for the FMC2000 MeshGuard controller. It covers third-party MeshGuard integration through the FMC2000 ModBus.

## 32.2 Communications Settings

Communication mode:

There are two modes can be selected on FMC2000 Modbus menu:

- Modbus RTU/ASCII on RS485
- Modbus RTU over TCP/IP

**Mode 1:** Communication Parameters for RS485 Interface

FMC2000: Slave

Baud Rate: 4800, 9600, 19200 (default)

Client ID: 1~246 (0x01~0xF6)

Data Format:

Data bits: 8

Check bits: none

Stop bits: 1

**Mode 2:** Modbus RTU over TCP/IP

FMC2000 supports Modbus RTU over TCP on its Ethernet port. It is not the standard Modbus TCP.

The FMC2000 controller is a client to connect to a server (the default listening port is 9724, configurable).

Once connected, the server needs to send the request command(s) to FMC2000 controller to get the monitor



## FMC2000 User's Guide

information. The server IP and TCP port must be properly configured on FMC2000 controller. It is also necessary to configure the IP settings for the FMC2000 controller. After configuration, the FMC2000 tries to connect to the specified server.

The FMC2000 does not check the “ClientID” (the first byte in the request message; refer to the section below) in the ModBus RTU message. However, the FMC2000 replies to a message with its “ClientID.”

### 32.3 Message Frame/Communication Procedure

**Note:** The FMC2000 supports Function Code 0x03 only.

#### 0x03 : Read Holding Registers

The Requesting Message:

Device Address	Function Code	Starting Address high byte	Starting Address low byte	Quantity of Registers high byte	Quantity of Registers low byte	CRC low byte	CRC high byte
Client ID	0x03	addr	addr	qty	qty	crc	crc

Note: The max Quantity value is 48.

The Answering Message:

Device Address	Function Code	Byte Count	Register Values	CRC low byte	CRC high byte
Client ID	0x03	len	MSB.....LSB	crc	crc

## 32.4 Registers Table

### (1) 0x03 (Read Holding Registers)

FMC2000 controller supports up to 24 monitors by following the MeshGuard system specification. The entire register space is divided into 24 blocks. One block register space corresponds to a monitor's data registers. A monitor's basic address is located from 0x0000 to 0x0690 (#1 basic address: 0x0000, #2 basic address: 0x0030, #3 basic address: 0x0060 . . . , #24 basic address: 0x0690). Step value is 0x30.

### Terminology

**Monitor:** Refers to the actual unit (MeshGuard, etc.).

**Sensor:** Refers to the sensor inside the monitor. One monitor may have more than one sensor and up to eight sensors.

MeshGuard is single-gas monitor and has only one sensor.

### Monitor data and register offset addresses:

Start offset address	Length (2 Bytes)	Response data	Remarks
0x0000	0x0001	byte[0] = Status byte[1] = SysOnlineNum	Status: the monitor's data availability  0: unavailable 1: available  SysOnlineNum: the number of online monitors in the FMC2000
0x0001	0x0001	byte[0] = SlaveID high byte[1] = SlaveID low	Monitor slave ID (or radio ID displayed on the FMC2000 screen)  Data format: Hex. Example: SlaveID = 0x4011 means the monitor wireless ID is "4011."

## FMC2000 User's Guide

Start offset address	Length (2 Bytes)	Response data	Remarks
0x0002	0x0005	byte[0 ~ 9] = SN [0 ~ 9]	Monitor's serial number: ASCII, 10 bytes
0x0007	0x0001	byte[0] = InstrID byte[1] = SenSkt	Instrument ID: refer to Appendix 1, sensor mask, to determine how many sensors. For MeshGuard, it is always 0x01.
0x0008	0x0001	byte[0] = UnitErr byte[1]: 0	monitor unit error status Refer to Appendix 4.
0x0009	0x0001	byte[0] = DutyCycle high byte[1] = DutyCycle low	How often the monitor updates its reading
0x000A	0x0001	byte[0] = PwrStatus byte[1] = PwrPer	PwrStatus: 0: Battery only 1: charging 2: fully charged + AC 3: AC only PwrPer: The battery capacity in percentage
0x000B			Field 0x000B (reserved for future use)
0x000C	0x0004	byte[0] = SenID byte[1] = UnitID byte[2] = DataFormat B0..B1: DataLength B2..B4: DivideFactor B5...B7: DecimalPoint byte[3] = SenErr byte[4] = Rding higher byte[5] = Rding high byte[6] = Rding low byte[7] = Rding lower	First sensor info. Total 8 bytes SenID: refer to Appendix 2 UnitID: refer to Appendix 3 For byte2 bit Definition: DataLength: B0:B1 Always B0:0 B1:1 means 4 bytes DivideFactor = 10 <sup>n</sup> : B4 B3 B2 0 0 0 - 1 0 0 1 - 10

## FMC2000 User's Guide

Start offset address	Length (2 Bytes)	Response data	Remarks
			0 1 0 - 100 0 1 1 - 1000 1 0 0 ~ 111: Reserved for future use  DecimalPoint: B7 B6 B5 0 0 0 - 0 0 0 1 - 1 0 1 0 - 2 0 1 1 - 3 1 0 0 ~ 111: Reserved for future use  SenErr Refer to Appendix 5
...	...	...	...
0x0028	0x0004	byte[0] = SenID byte[1] = UnitID byte[2] = DataFormat B0..B1: DataLength B2..B4: DevideFactor B5..B7: DecimalPoint byte[3] = SenErr byte[4] = Rding higher byte[5] = Rding high byte[6] = Rding low byte[7] = Rding lower	The 8th sensor info.
0x002C	0x0004	byte[0 ~ 7] = Location String [0 ~ 7]	Location: ASCII & CHN Font code, 8 bytes;

# FMC2000 User's Guide

## Appendix 1: Supported Instrument IDs

0x00 Unknown  
0x01: MeshGuard  
0x02: RAEWatch  
0x03: RAETag  
0x04: Router  
0x05 ToxiRAE Pro  
0x06 MultiRAE  
0x07 QRAE3  
0x08 RAEPoint Switch

## Appendix 2: Supported Sensor IDs

0x00: Unknown  
0x01: CO  
0x02: H<sub>2</sub>S  
0x03: LEL  
0x04: Gamma  
0x05: SO<sub>2</sub>  
0x06: Temperature  
0x07: Motion  
0x08: VOC  
0x09: IR  
0x0A: CO<sub>2</sub>  
0x0B: O<sub>2</sub>  
0x0C NH<sub>3</sub>  
0x0D NO<sub>2</sub>  
0x0E NO  
0x0F Cl<sub>2</sub>  
0x10 ClO<sub>2</sub>  
0x11 ETO  
0x12 H<sub>2</sub>  
0x13 HCl  
0x14 HCN  
0x15 HF  
0x16 CH<sub>3</sub>SH

## FMC2000 User's Guide

0x17 COCl<sub>2</sub>  
0x18 PH<sub>3</sub>  
0x19 N<sub>2</sub>  
0x1A HCHO  
0x1B Neutron

### Appendix 4: Supported Unit IDs

0x00: “ ” (Unknown)  
0x01: ppm  
0x02: %  
0x03: μSv/h  
0x04: μR/h  
0x05: DegC  
0x06 w/m<sup>2</sup>  
0x07 ppb  
0x08 DegF  
0x09 mg/m<sup>3</sup>  
0x0A “ ” (Space)  
0x0B %LEL  
0x0C %VOL

### Appendix 4: Unit Error Definitions

Unit Error byte is as follows:

Bit	Description
0 (LSB)	Power: 1 = ON, 0 = Off
1	Battery: 1=Low, 0= Normal
2	Pump: 1=Stall, 0=Normal or not installed
3	Memory: 1=Full, 0=Normal or not installed
4	Sensor mask = bit map for 1-8 sensors
5	Unit Failure: 1=Failure, 0=OK
6	0, reserved for future use
7 (MSB)	0, reserved for future use

## FMC2000 User's Guide

### Appendix 5: Sensor Error Definitions

Sensor Error byte is as follows:

Bit	Description
0 (LSB)	Over Range: 1=fail, 0=normal
1	MAX: 1=fail, 0=normal
2	Sensor Failure: 1=fail, 0=normal If Sensor = PID Failure = Lamp Alarm Else if Sensor = LEL Failure = Off Else Failure (General)
3	High limit: 1=fail, 0=normal
4	Low limit: 1=fail, 0=normal
5	STEL limit: 1=fail, 0=normal
6	TWA limit: 1=fail, 0=normal
7 (MSB)	Drift: 1=fail, 0=normal

contém o módulo wireless: RM2400A



2783-14-6496



(01)07898911288388

Este equipamento opera em caráter secundário, isto é, não tem direito a proteção contra interferência prejudicial, mesmo de estações do mesmo tipo, e não pode causar interferência a sistemas operando em caráter primário.





**RAE Systems**  
**World Headquarters**

3775 N. First St.  
San Jose, CA 95134-1708 USA  
Phone: 408.952.8200  
Fax: 408.952.8480

**E-mail:** [customerserv@raesystems.com](mailto:customerserv@raesystems.com)

**Web Site:** [www.raesystems.com](http://www.raesystems.com)

Rev. H  
August 2014  
P/N F01-4001-000